

Chapter 14

VIMDUELITY

Like hungry flies,

Our players gather

*Will they
perish,*

*Or would
they rather*

Power through

*And chart
their story?*

*Heroes,
Villains,*

**FIGHT FOR
GLORY**

In the
FIRST GREAT

CENTRALIAN SCUFFLE

TOURNAMENT!

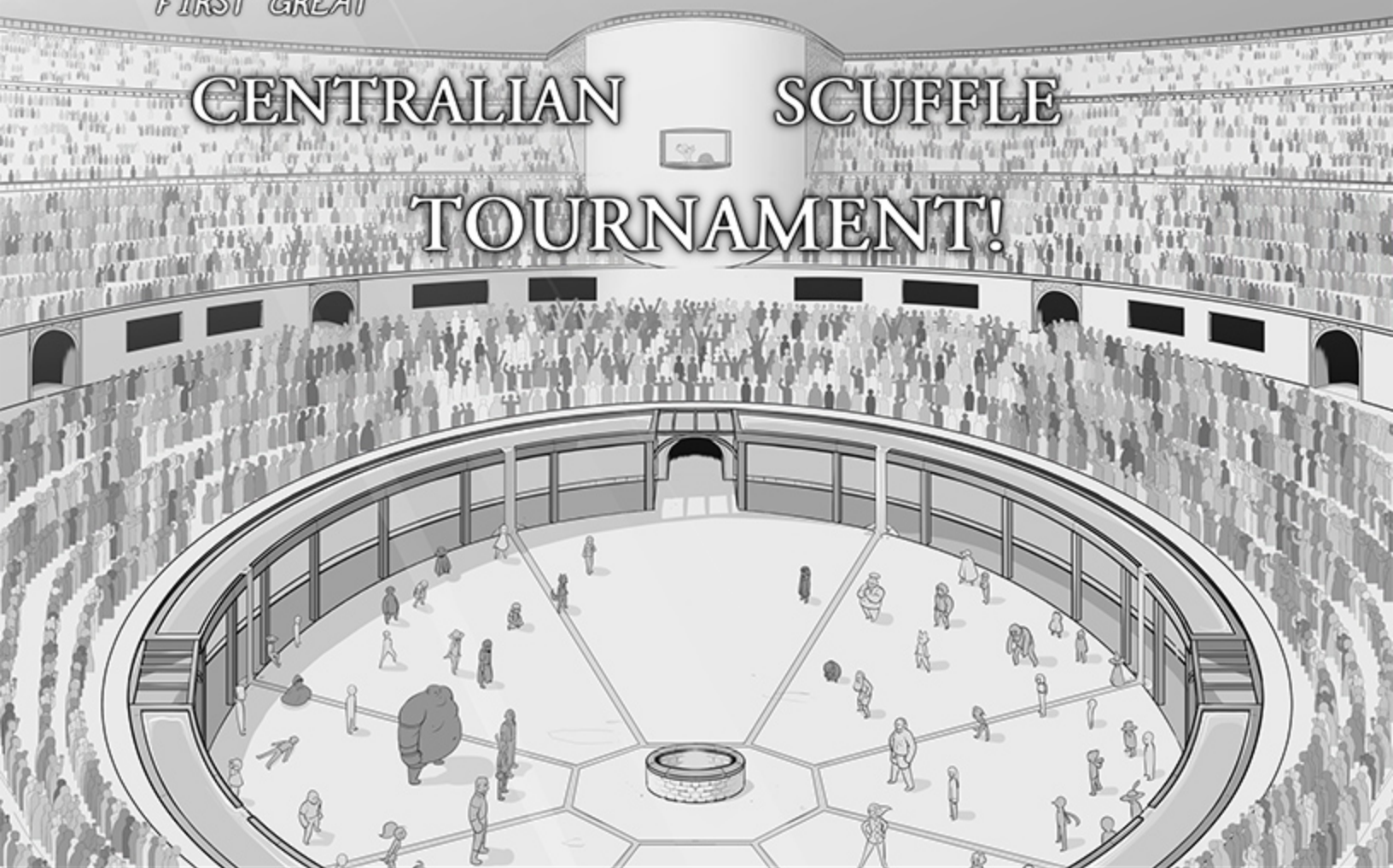

YEAAAAYAAAAHHH



Champions of the martial and mystic have gathered here at the newly-christened Middleburg Colosseum,

An architectural marvel largely spearheaded in the last year by the Card Man Collective.

Folks, I for one cannot imagine from what dark plane they mustered such ingenuity,

And I frankly fear the ends to which they desire to see us struggle in this parade of violence.

THANK YOU GEORRY.

Without further ado, it's what you're all here for:

Leg 1 of the Tournament...
SINGLES COMBAT!



Look at these 64 proud challengers,



All of whom passed the preliminary.

Remember them well...



And then get ready to forget half of them,

Because that's how many are making it to Leg 2!

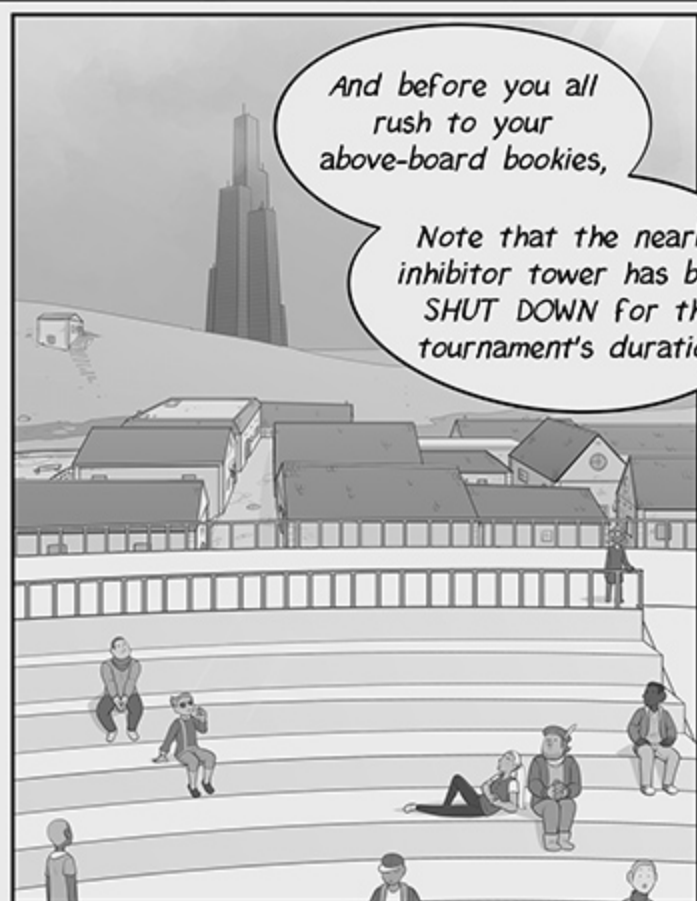

And before you all rush to your above-board bookies,

Note that the nearby inhibitor tower has been **SHUT DOWN** for the tournament's duration



To allow our more Monstrous participants to compete at their full strength.





The rules are simple.

The fight ends
when one person
surrenders or is
judged unable
to fight,

But no killing!
You kill your opponent,
you're out.

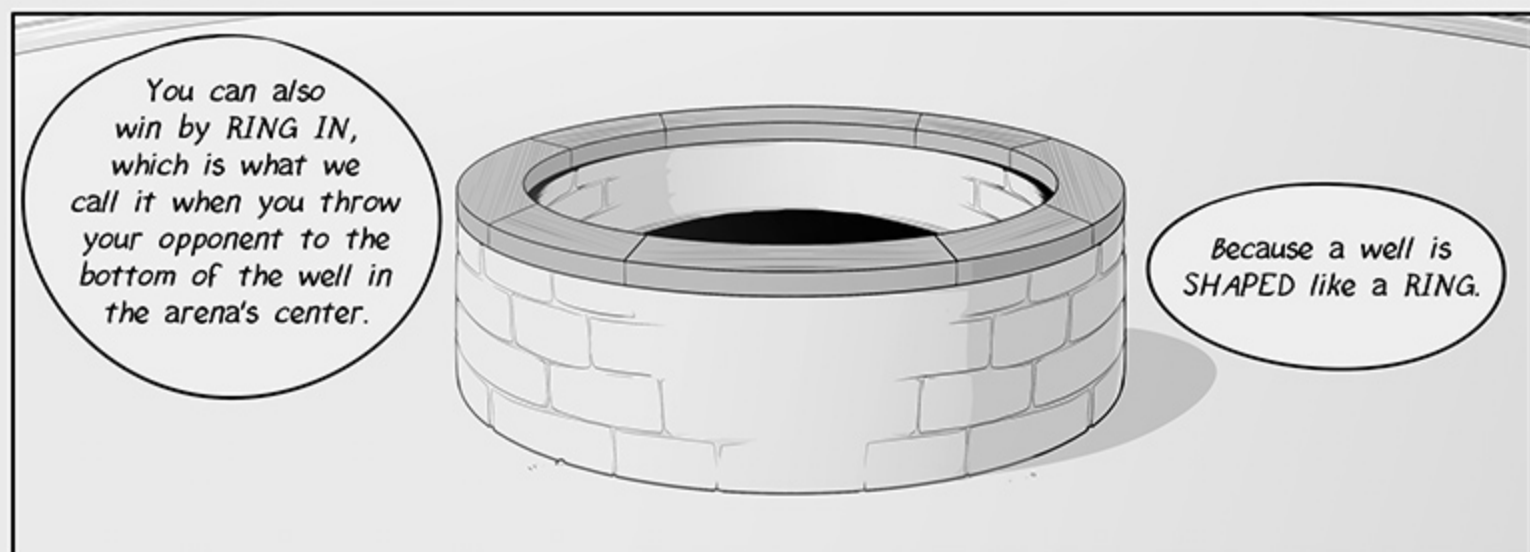

You can also
win by **RING IN**,
which is what we
call it when you throw
your opponent to the
bottom of the well in
the arena's center.

Because a well is
SHAPED like a **RING**.



Ey, dragon girl!



Pretty good view, huh?

It's a lil' higher up, but I gots powerful young eyes.



You gots any questions bout any of dese combatants, you let me know!



I gots dang near alla their cards.



Hmnmbrm sff'n frmr...

I don't know what season zero is supposedta mean.

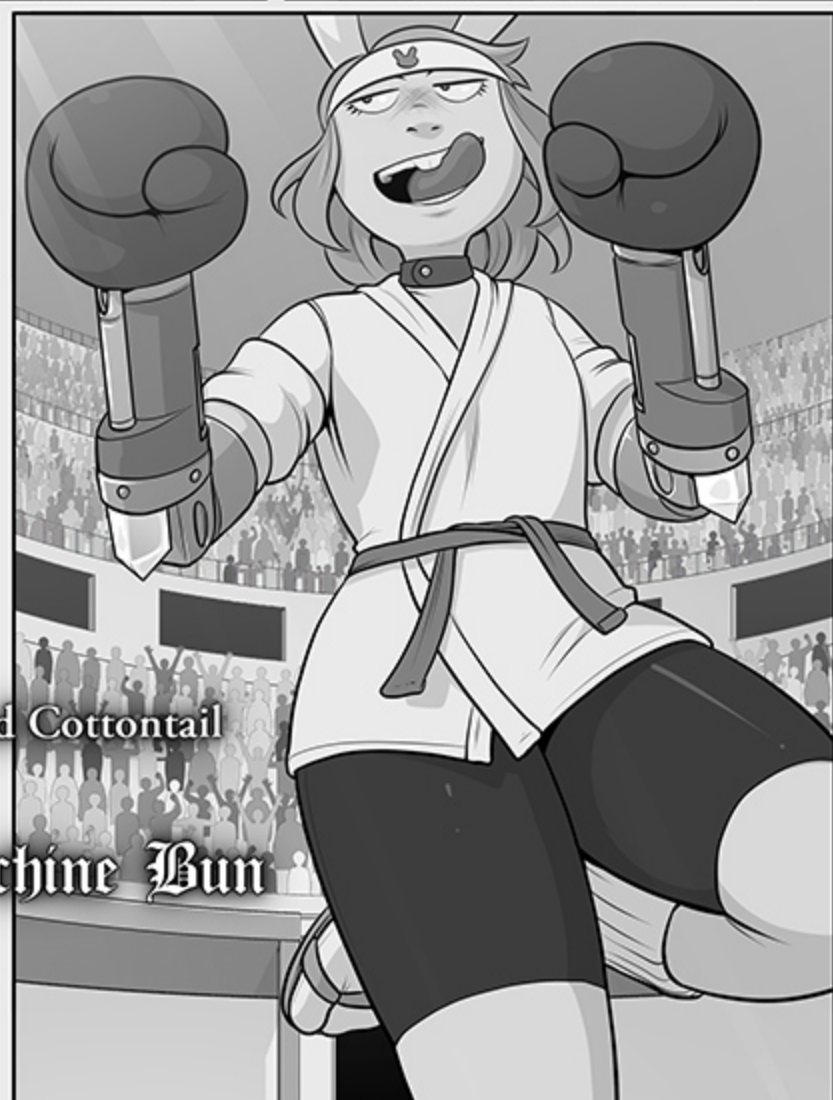
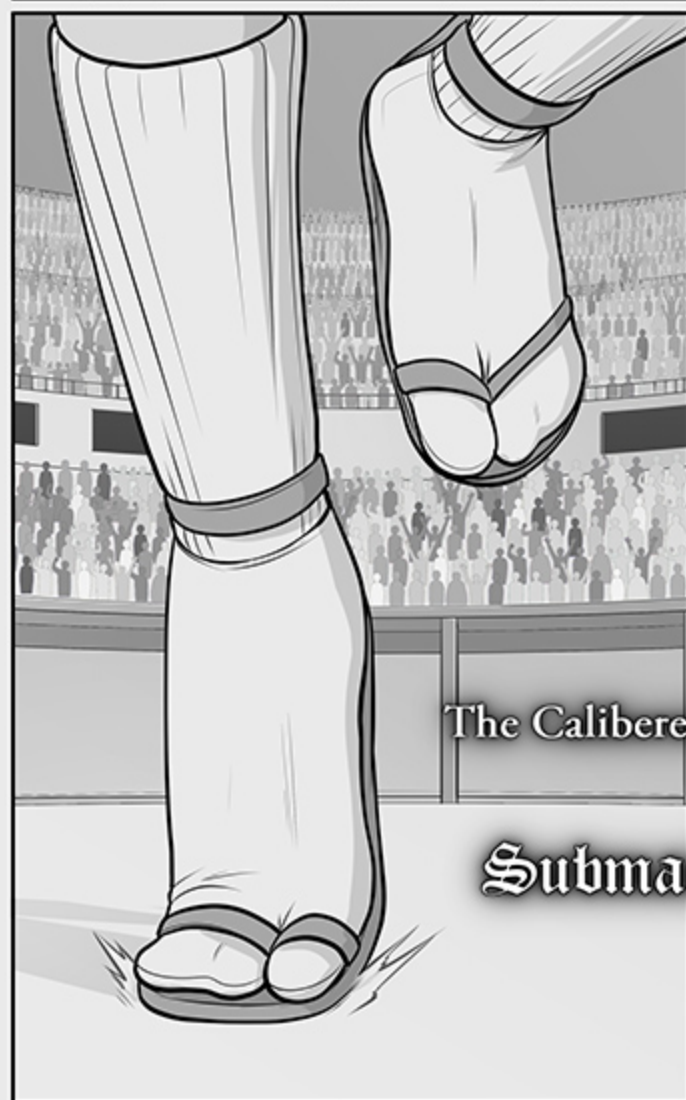

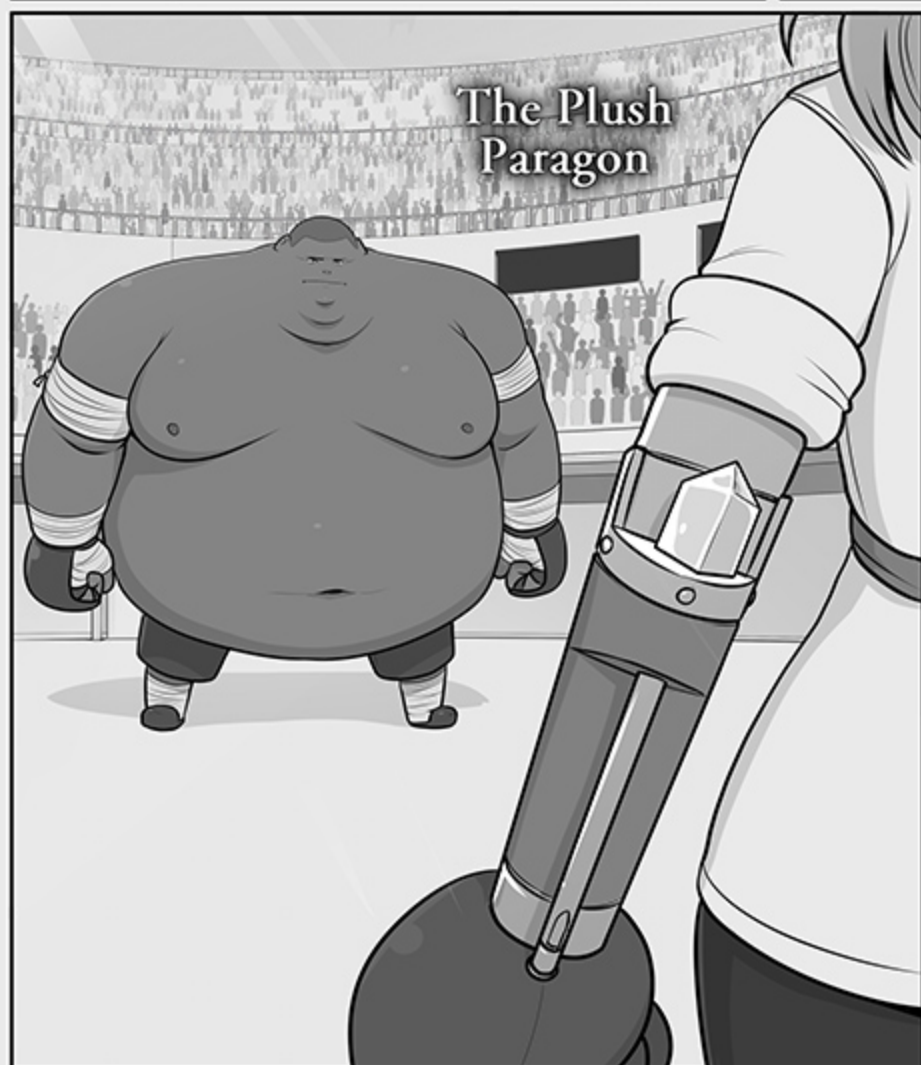
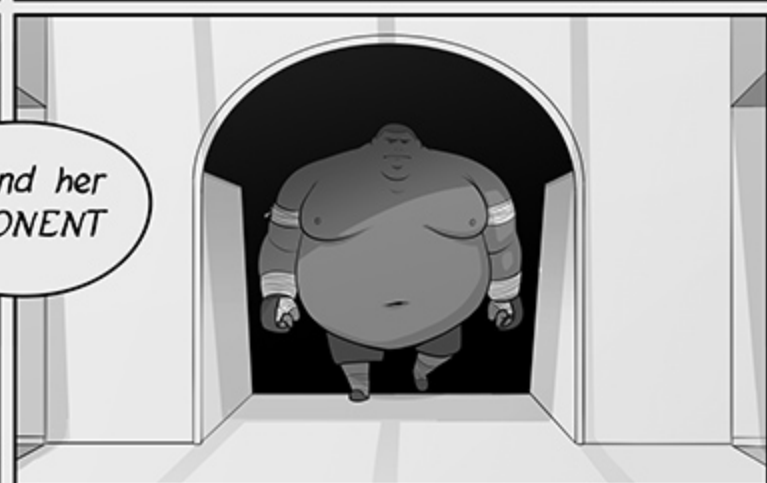
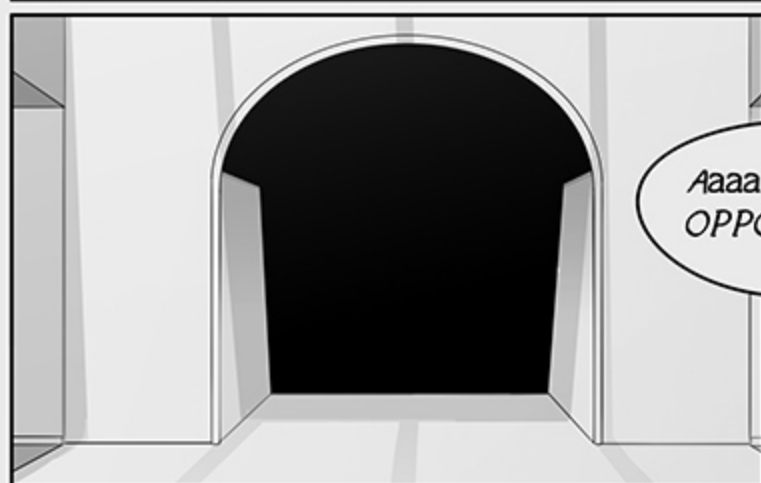



Walter don't look too threatenin',

But his unique build and thick skin let him shrug off blows what like a walking mattress man.



It's a rough matchup for da Bun...



Hey, do you uh... have a Windy Knight card?

Do I!



One'a Central's Eight Great Knights, dey say she's a hooorrible old witch who's walked da soil for hundreds'a years,



But now she only leaves her dank lair to unless devastating storms at da King's command.



HMPH.



GULP



FIGHT



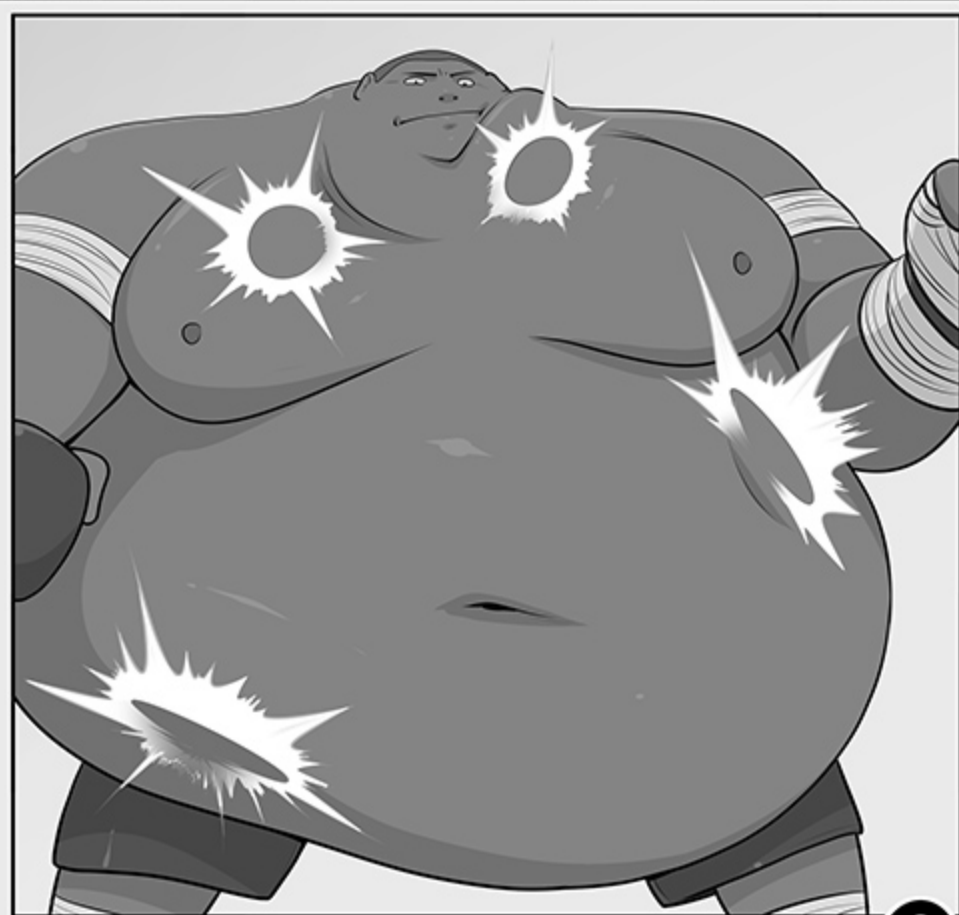

HWOOOOOOOO



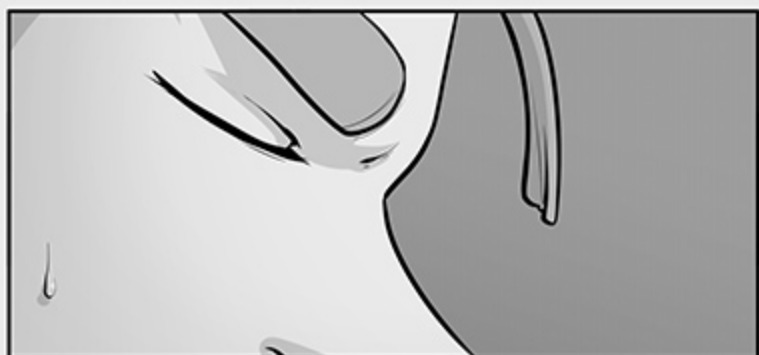

Cheery Cordial

Versus

Tabby Tamer



HOLD IT

It has come to our attention

That Cheery Cordial ALREADY HAS an Ultra-Rare card variant

And is NOT VIABLE for participation a la the tournament's guidelines!

Oh boy, I do?

What

Oh my, what a day of delightful surprises!

Huh



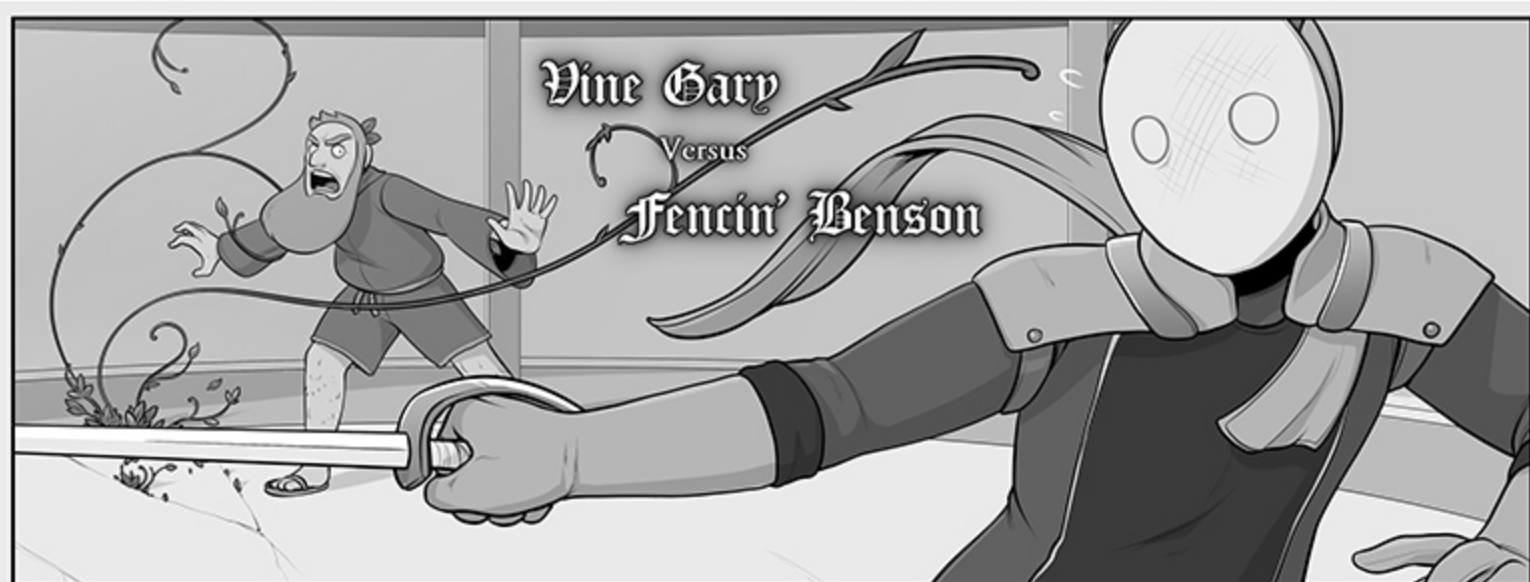
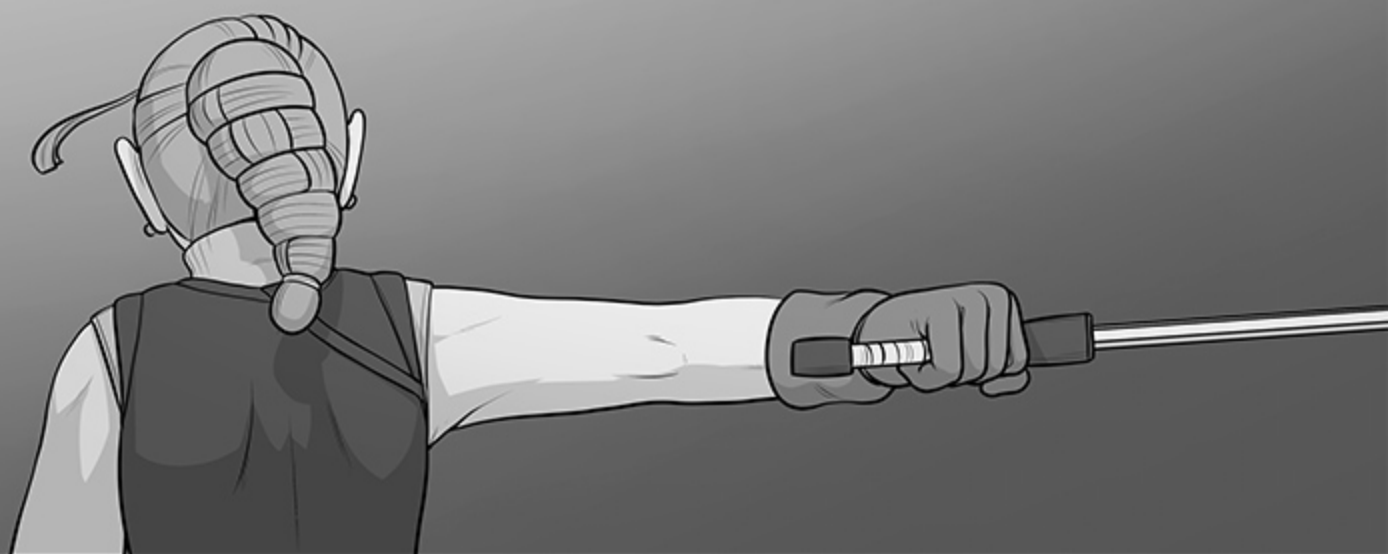
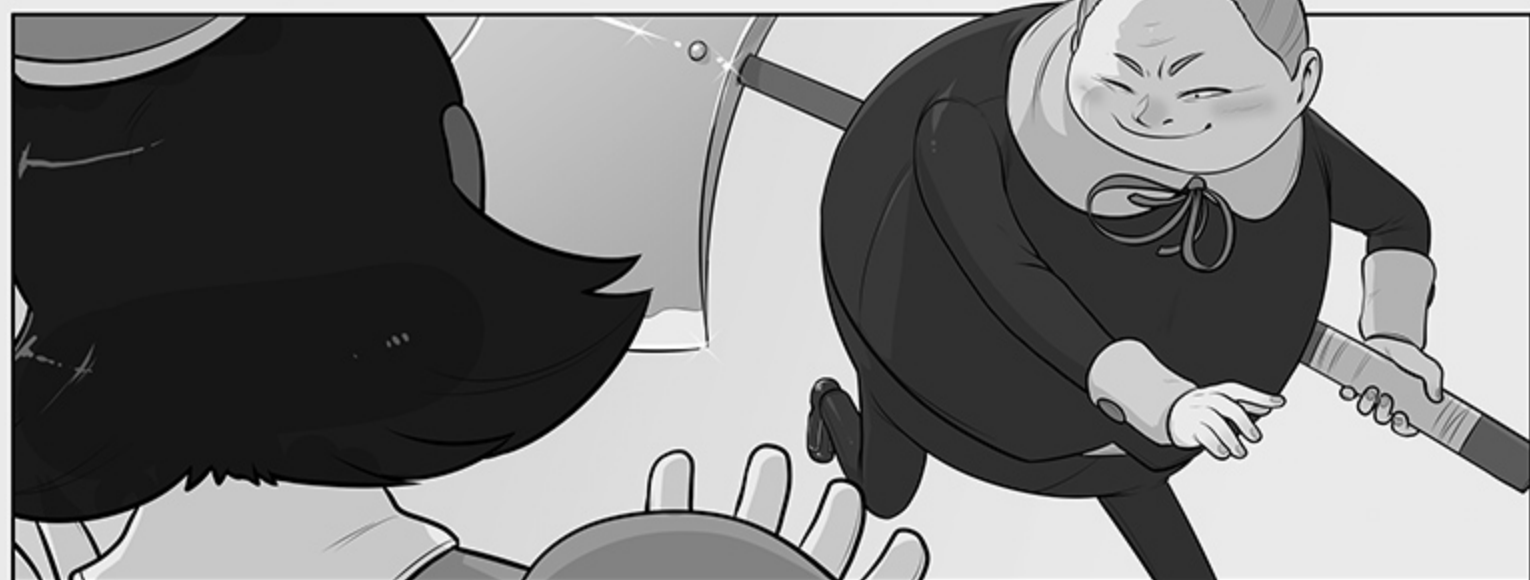
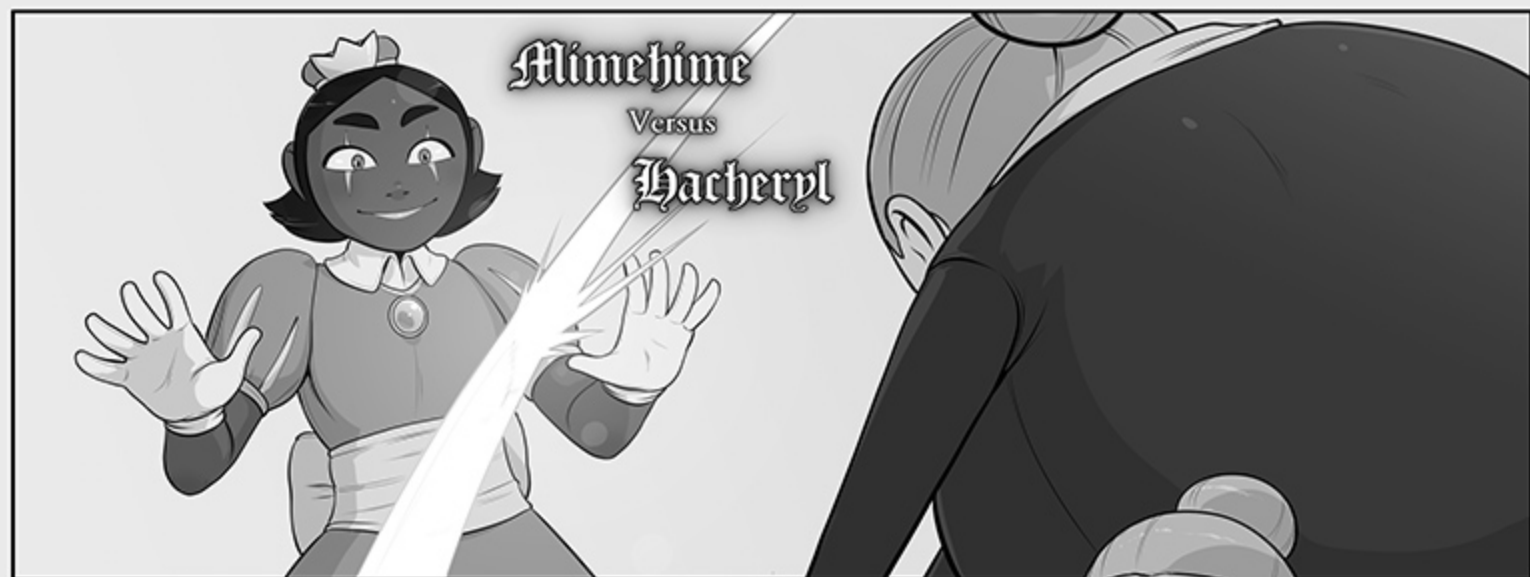





The
Wooden
Ghost

Brianne
Ironheart



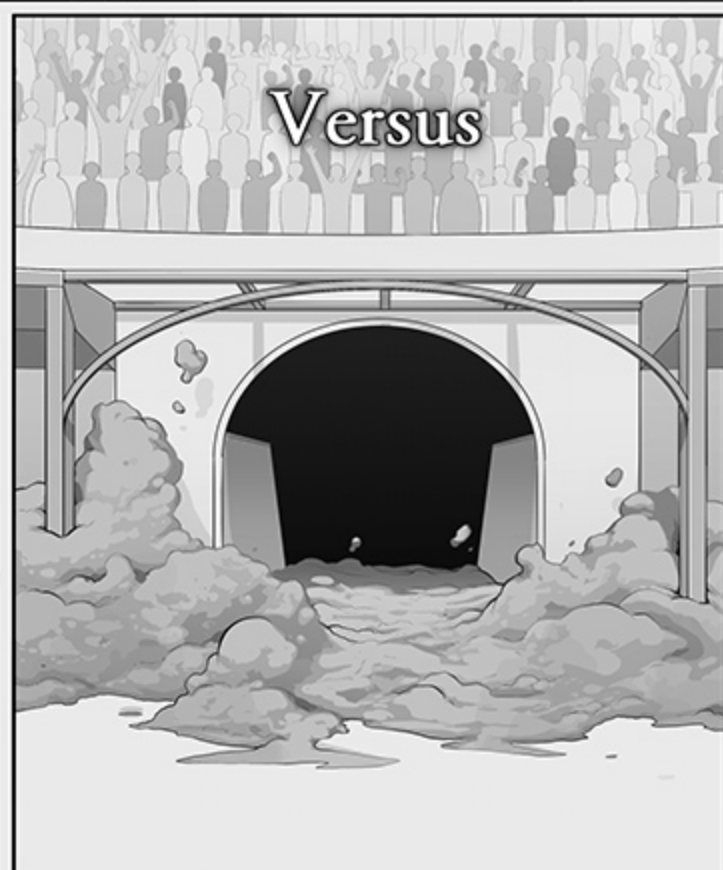

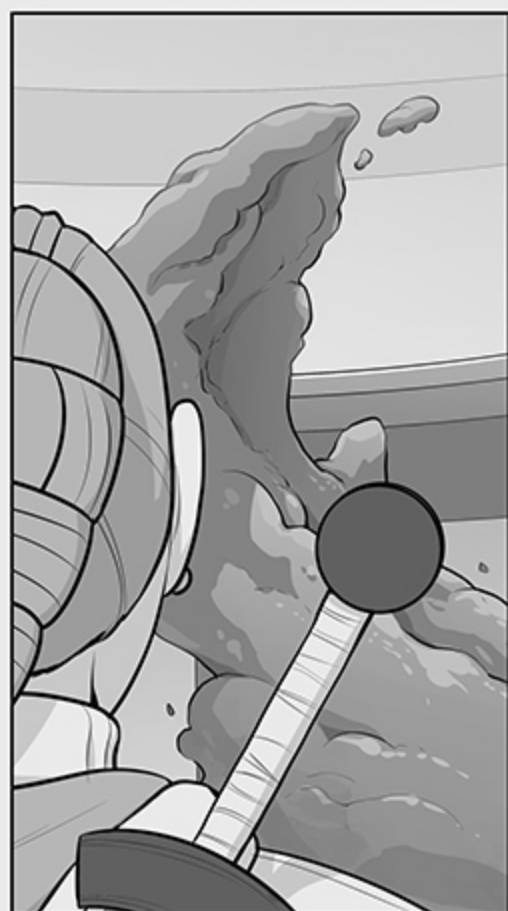

Moxie

Knight

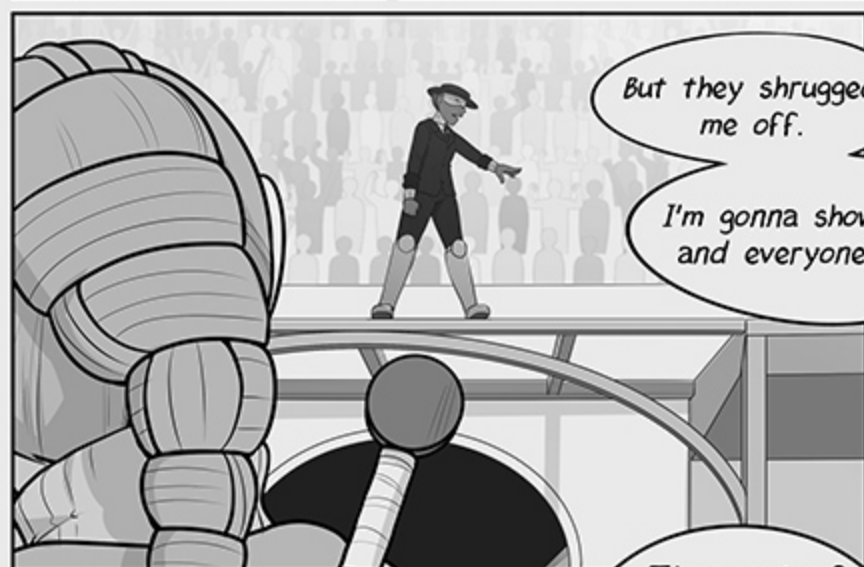

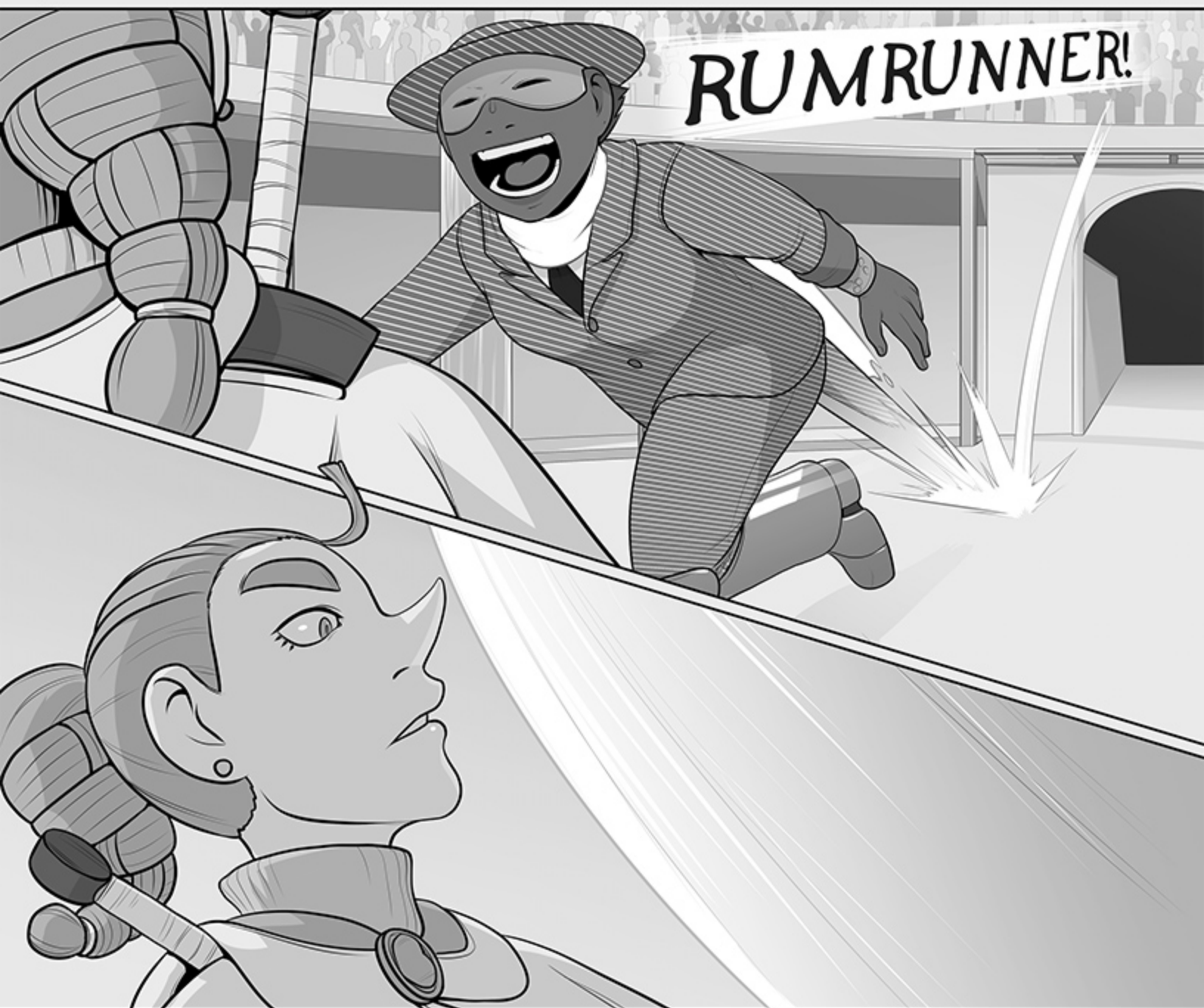
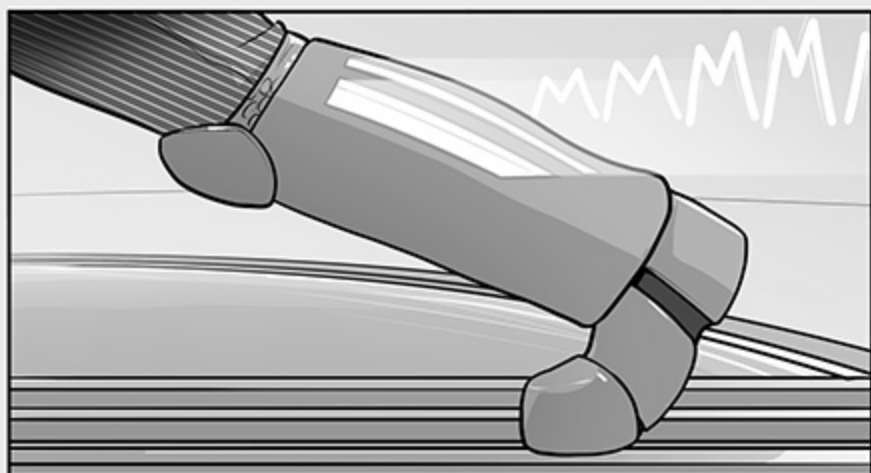
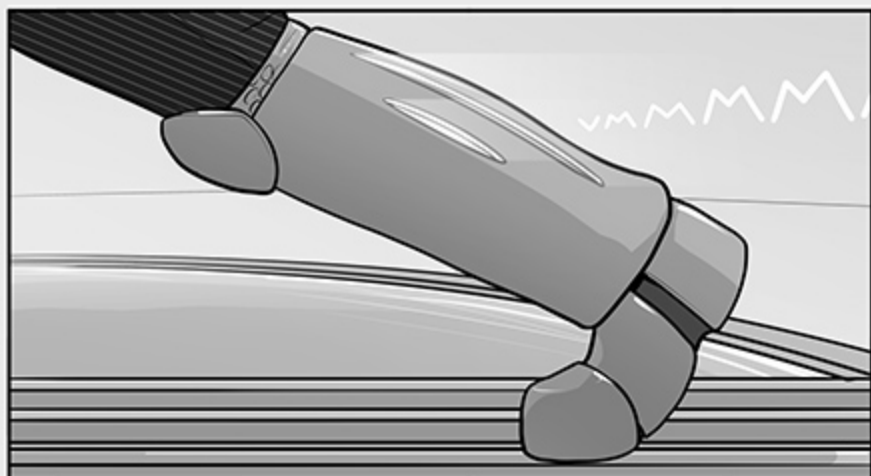

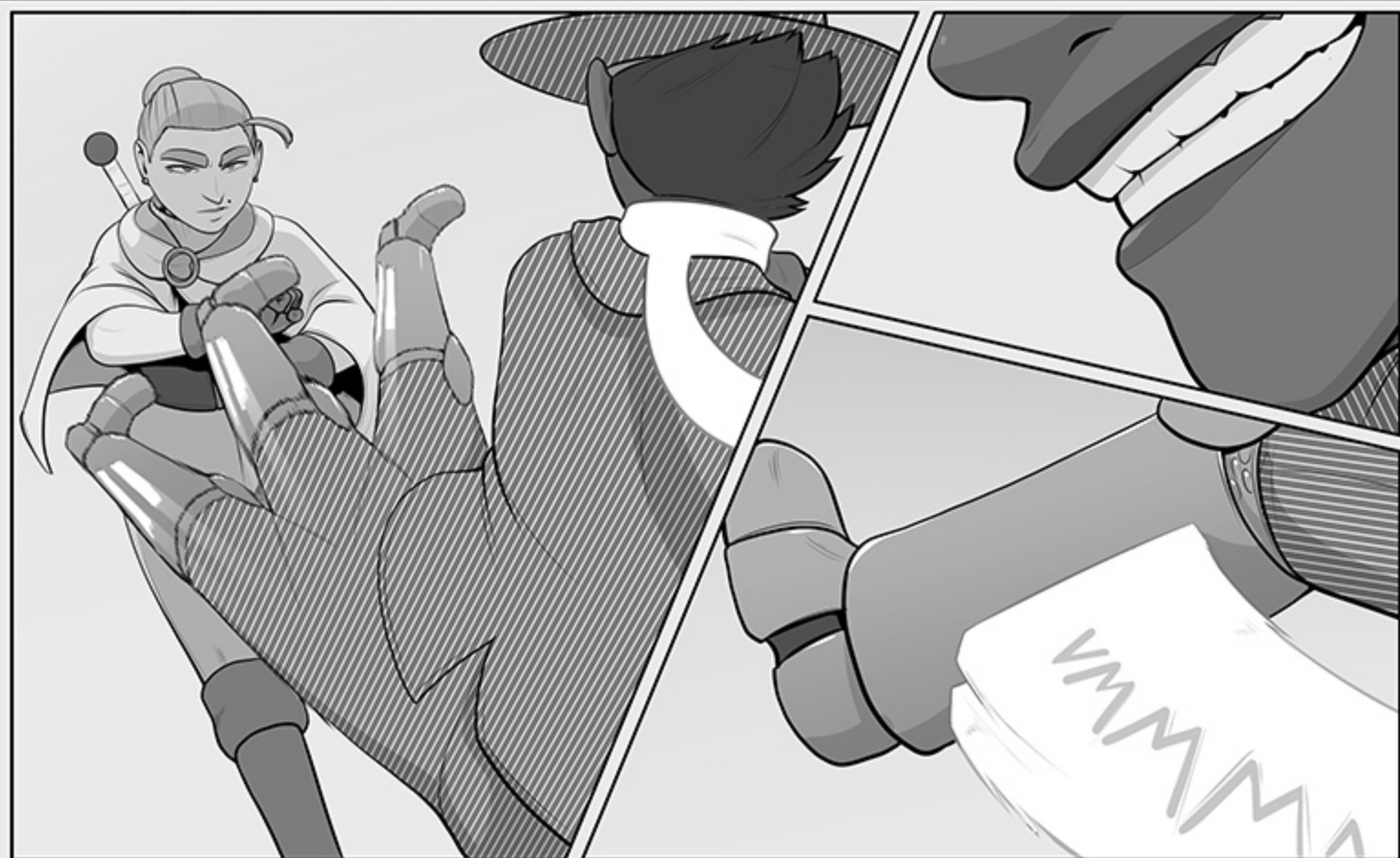

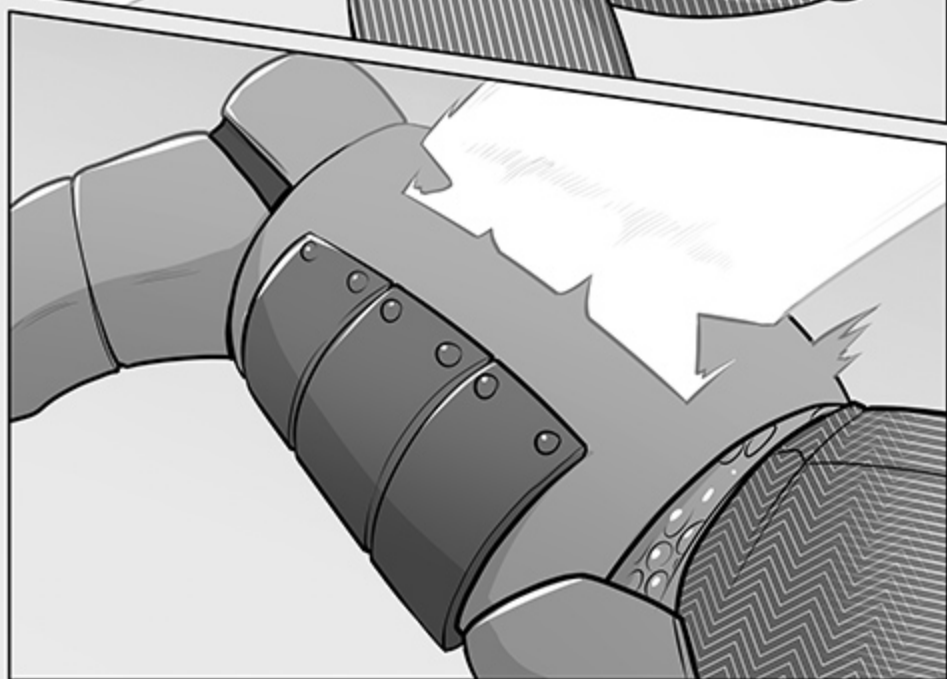

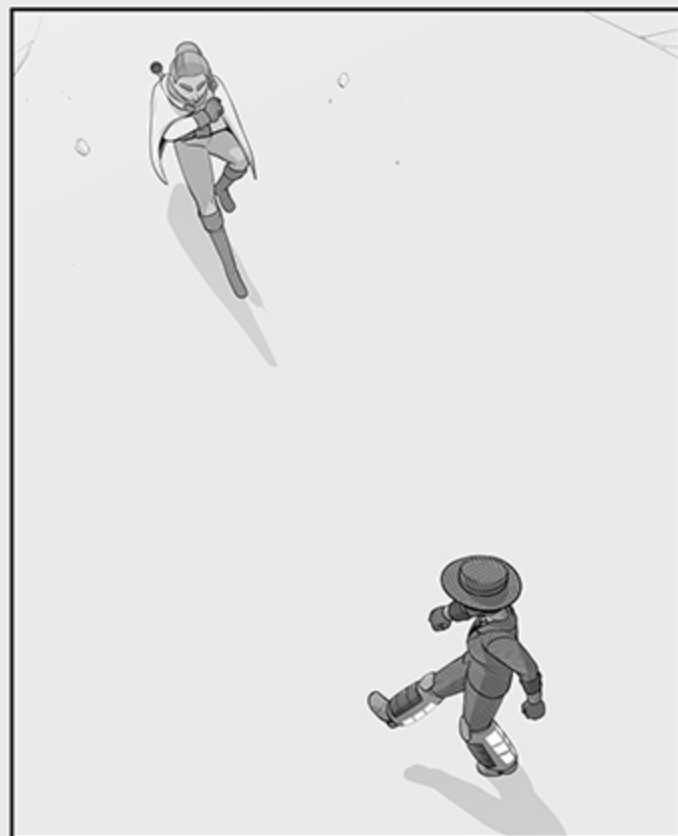

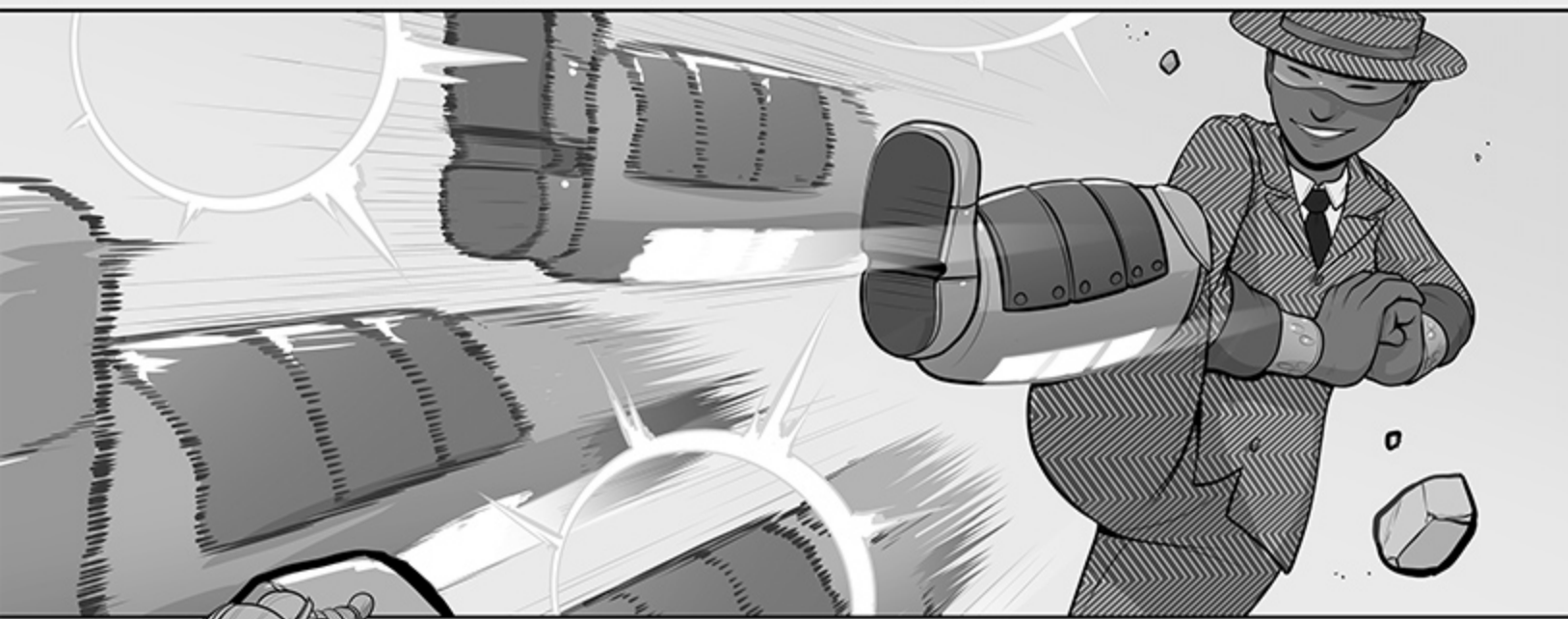
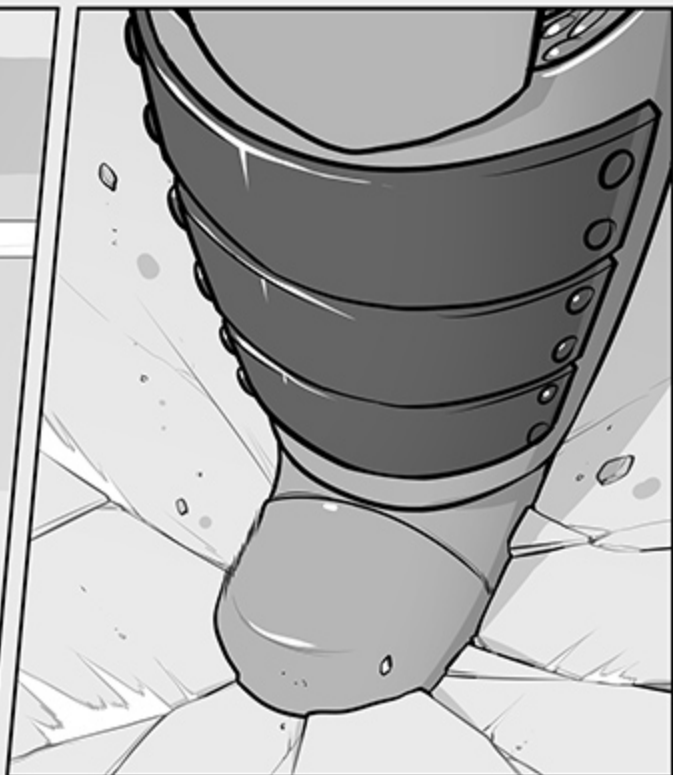

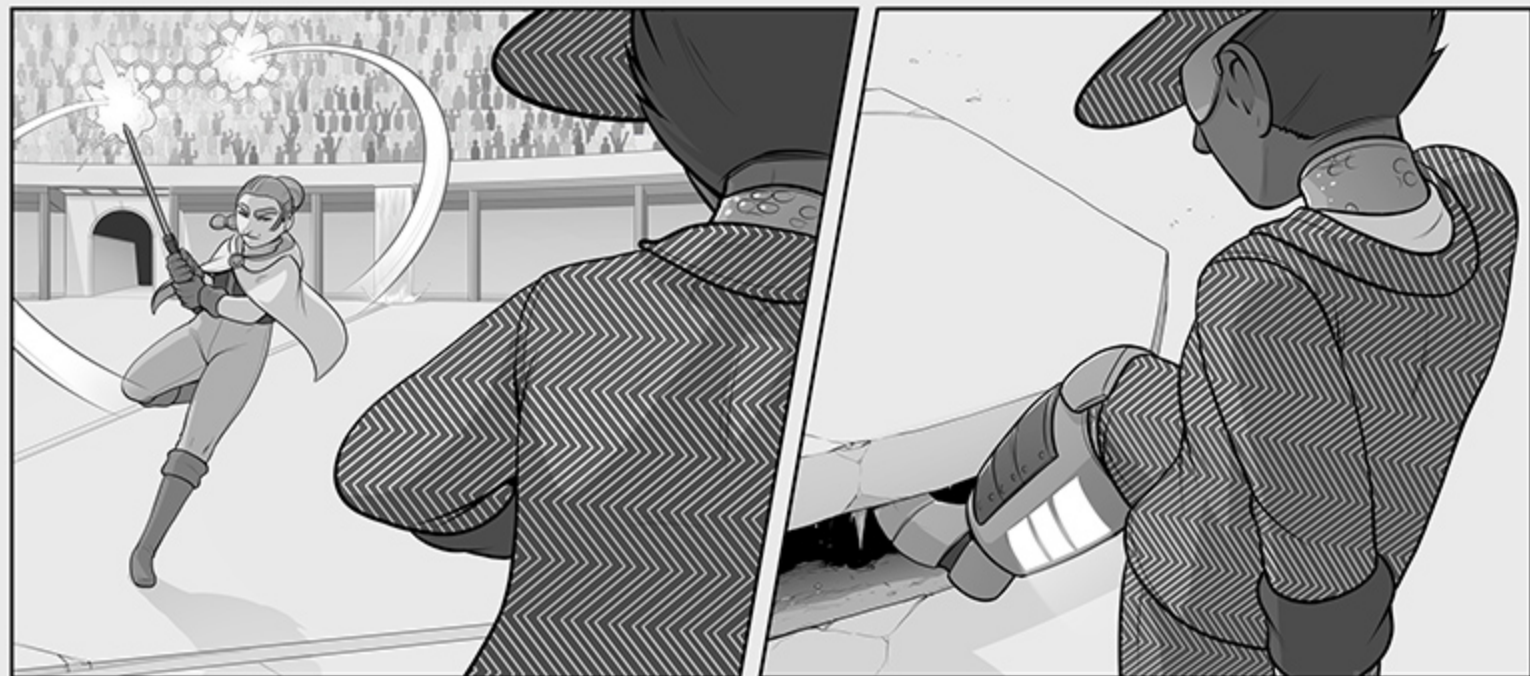

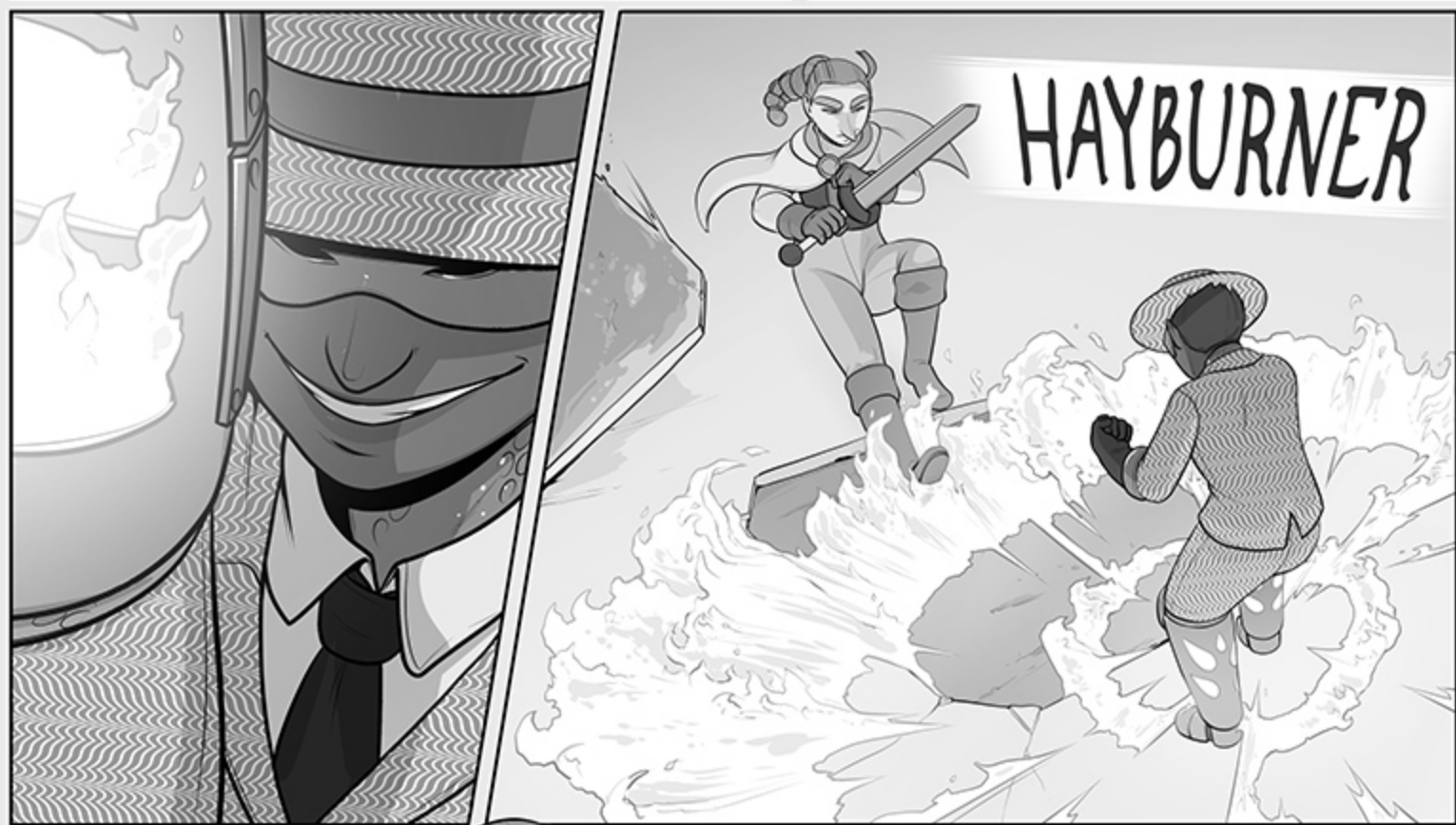
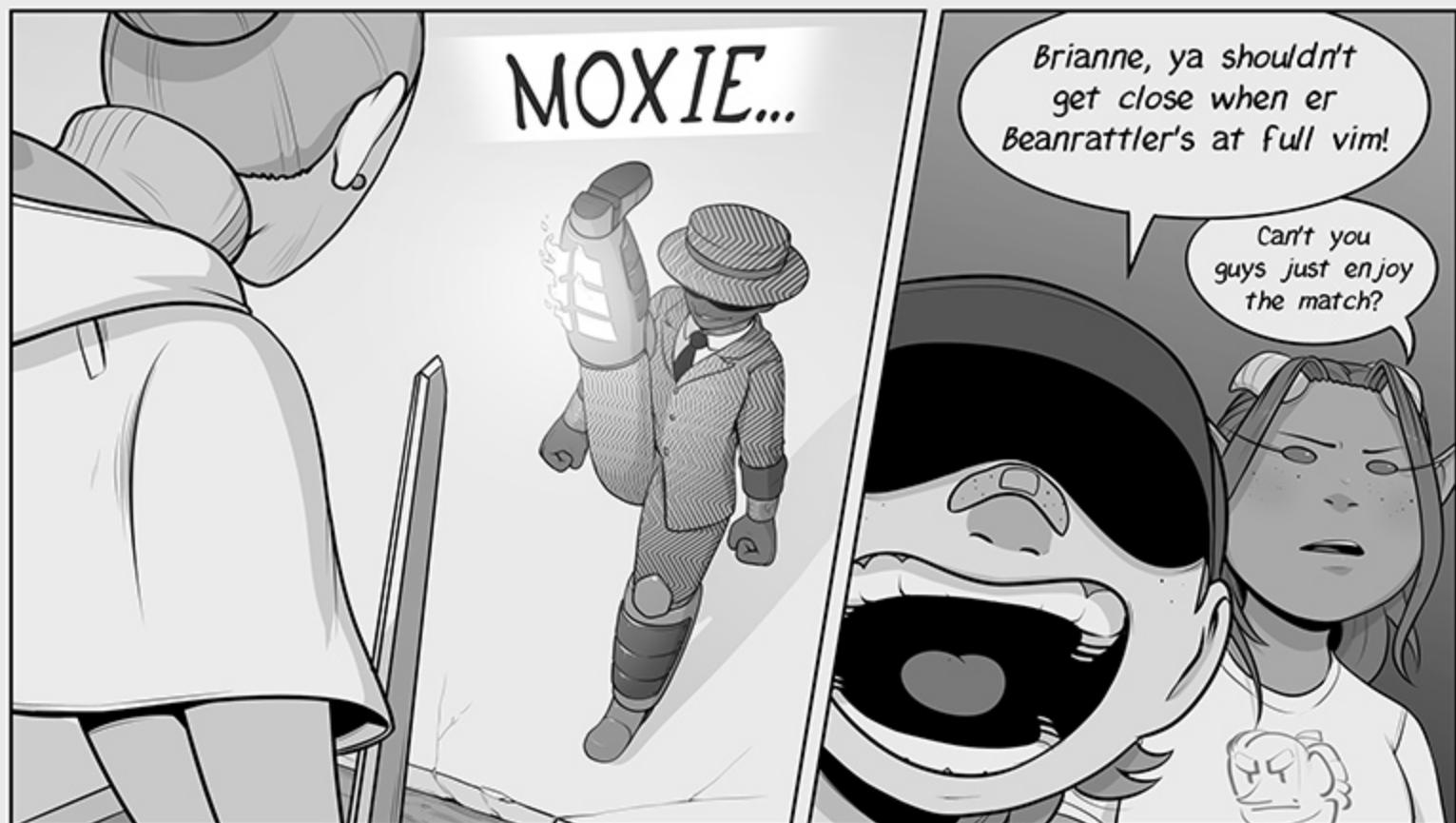

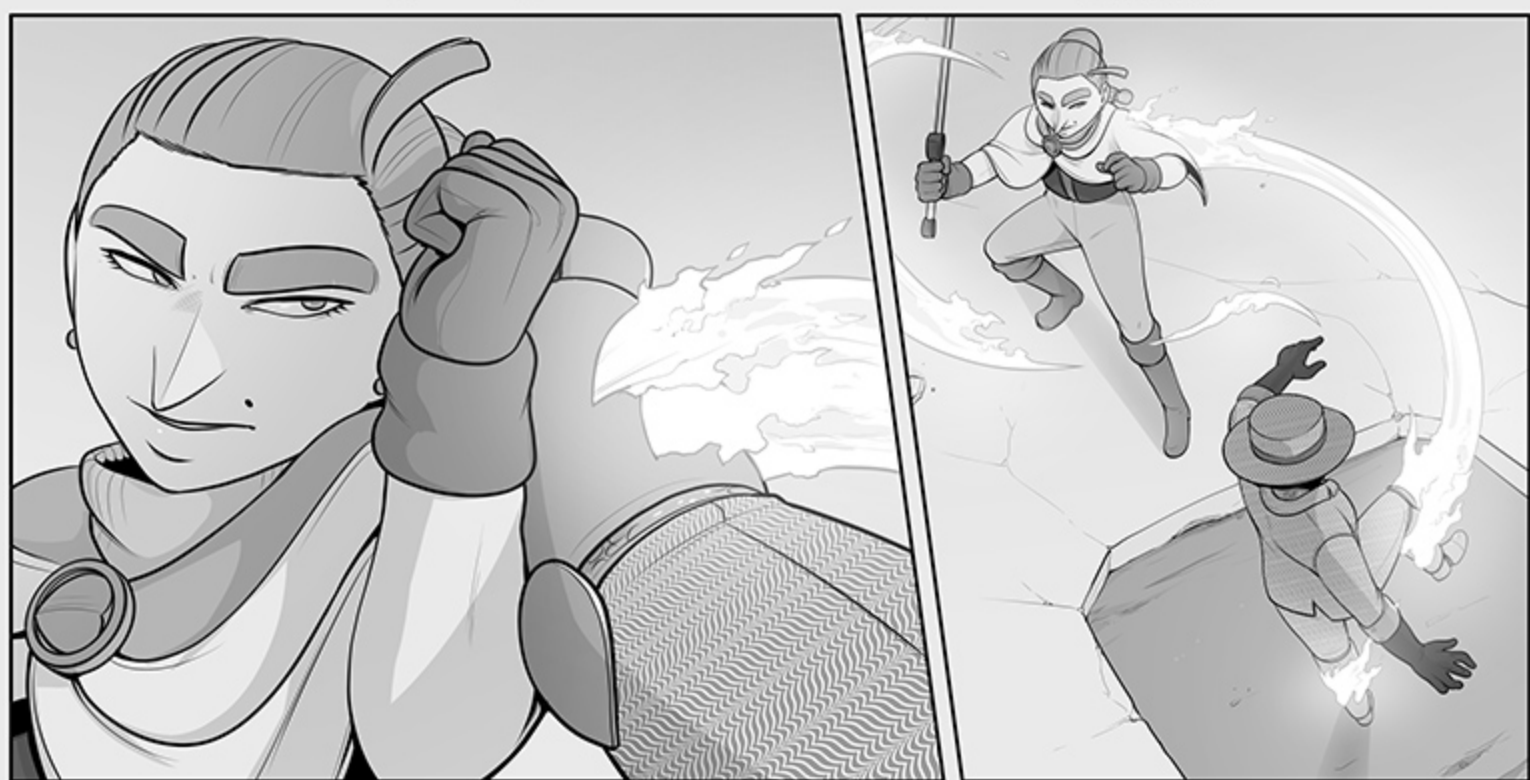
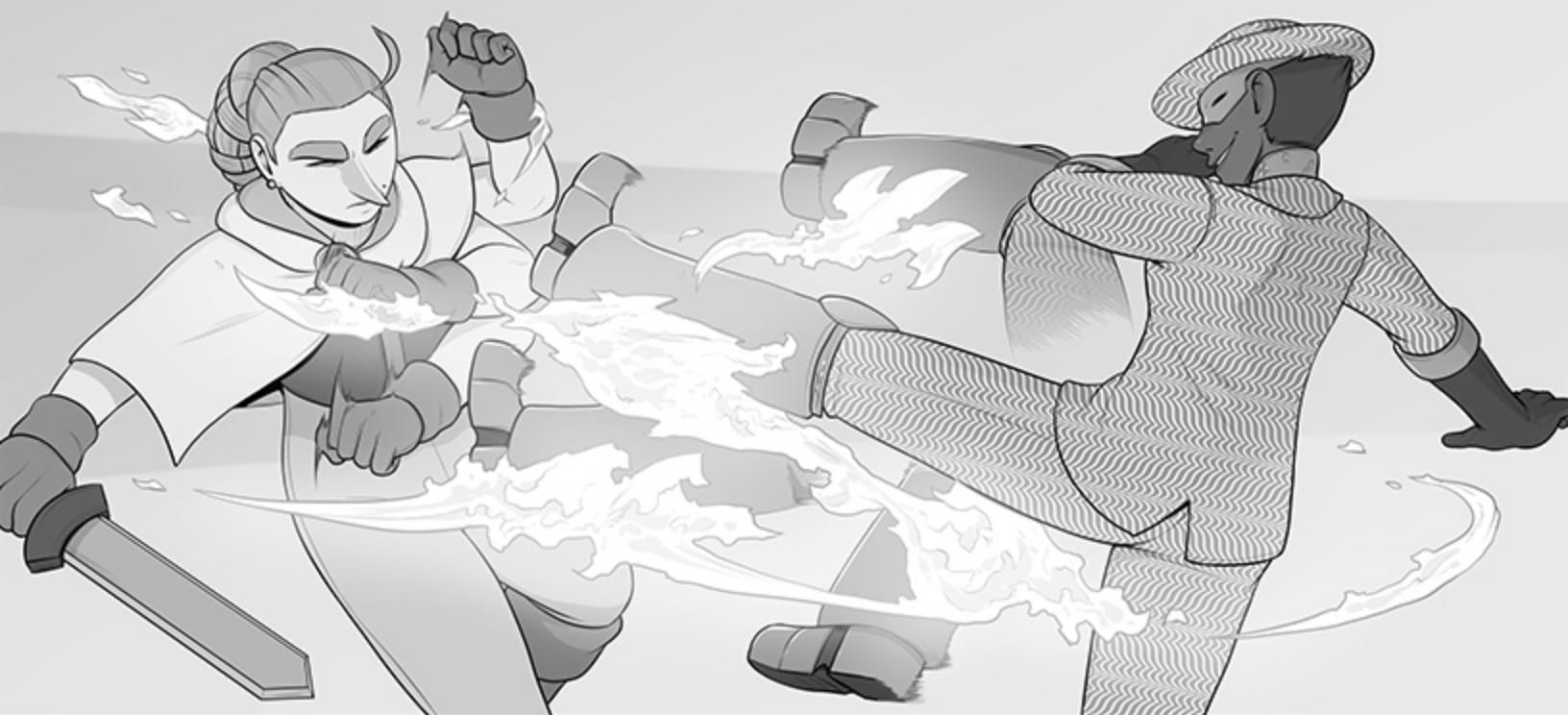

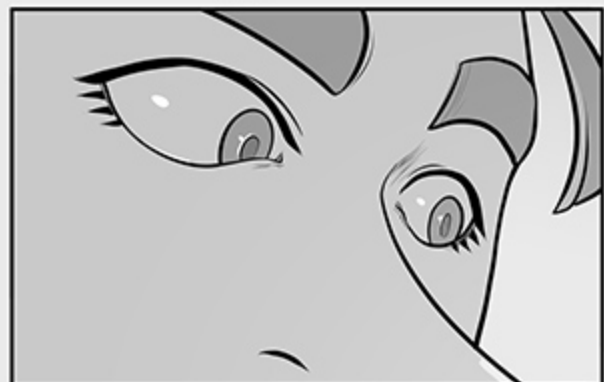
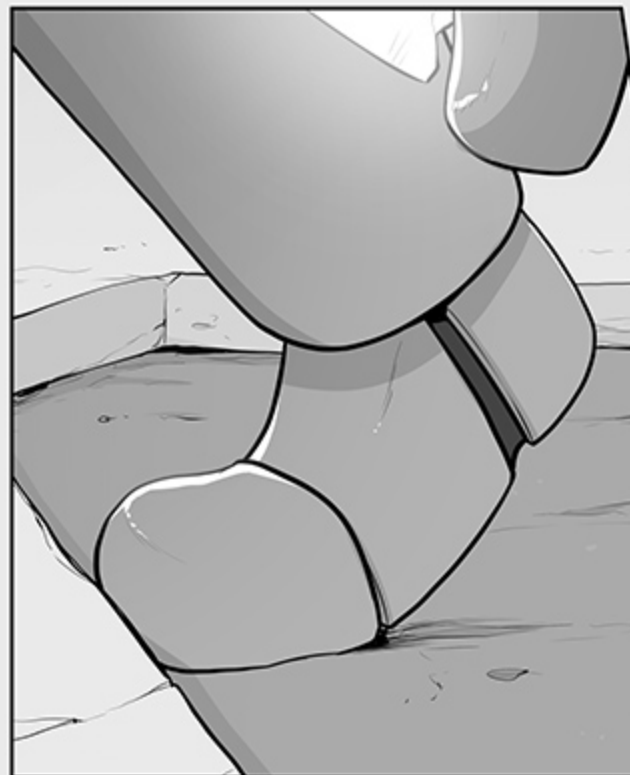

MOXIE...

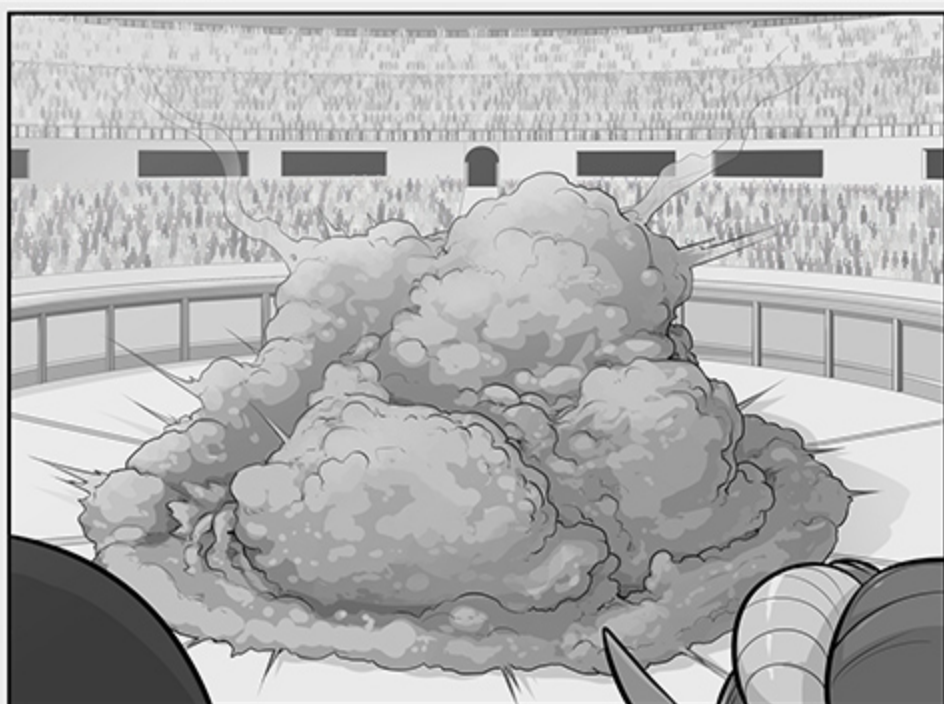



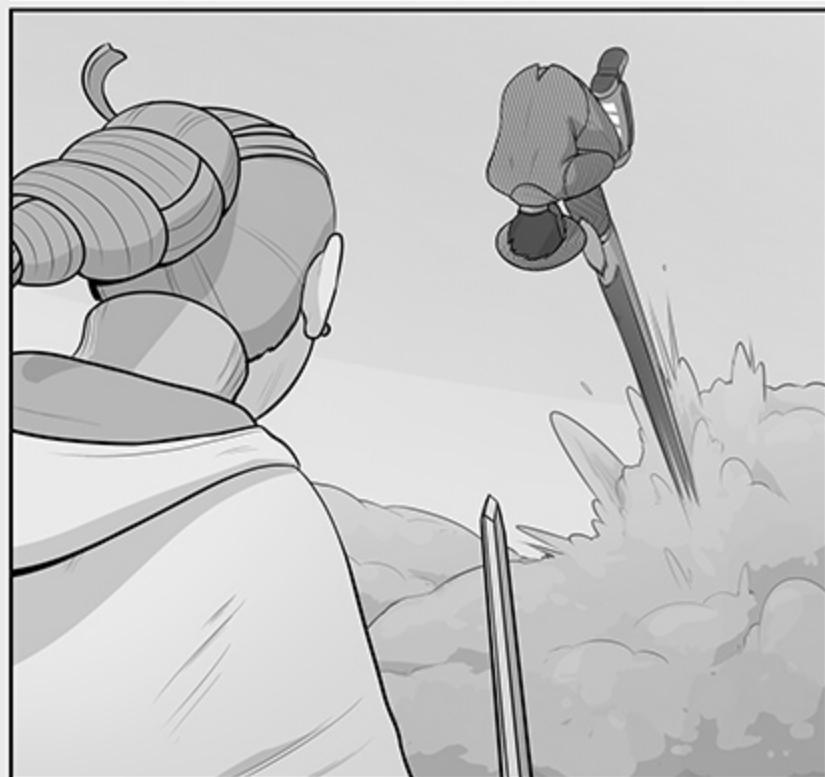

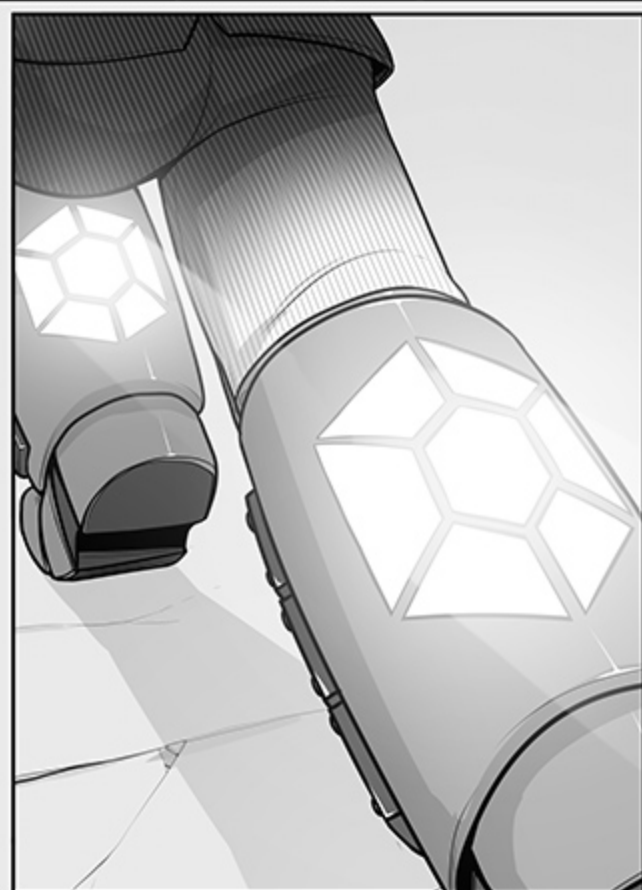



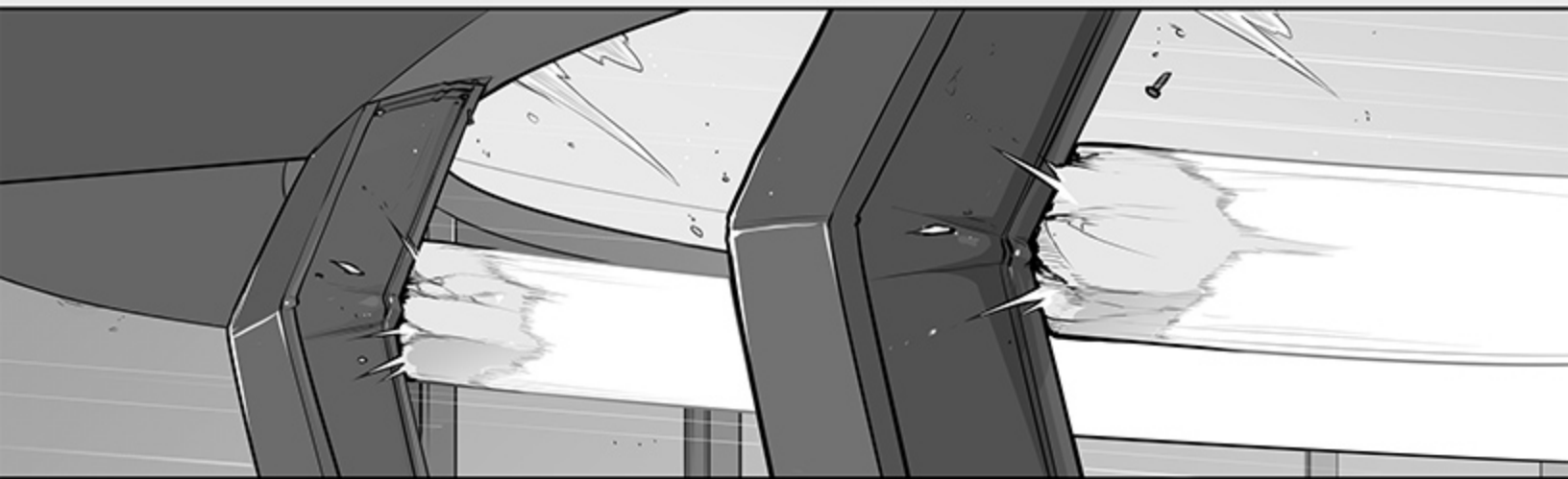
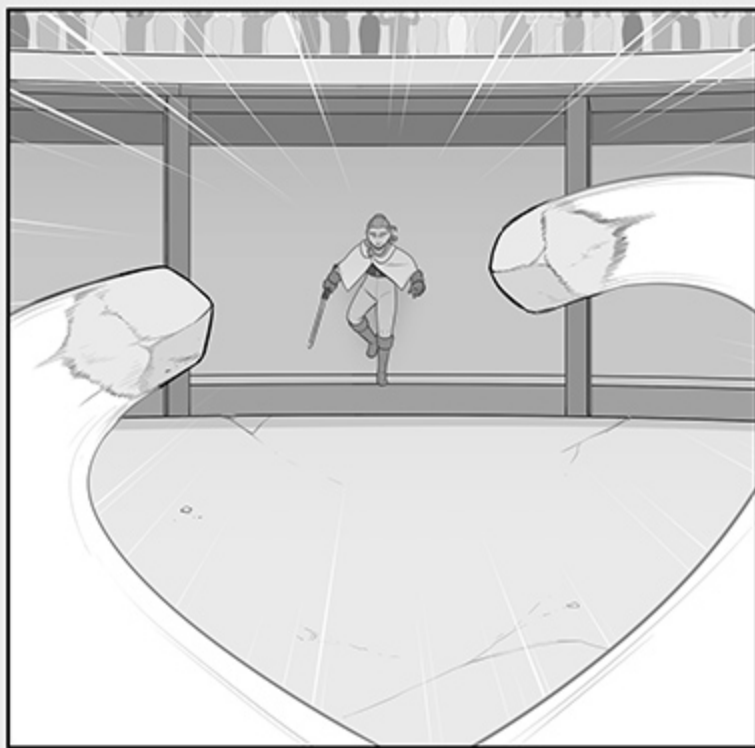
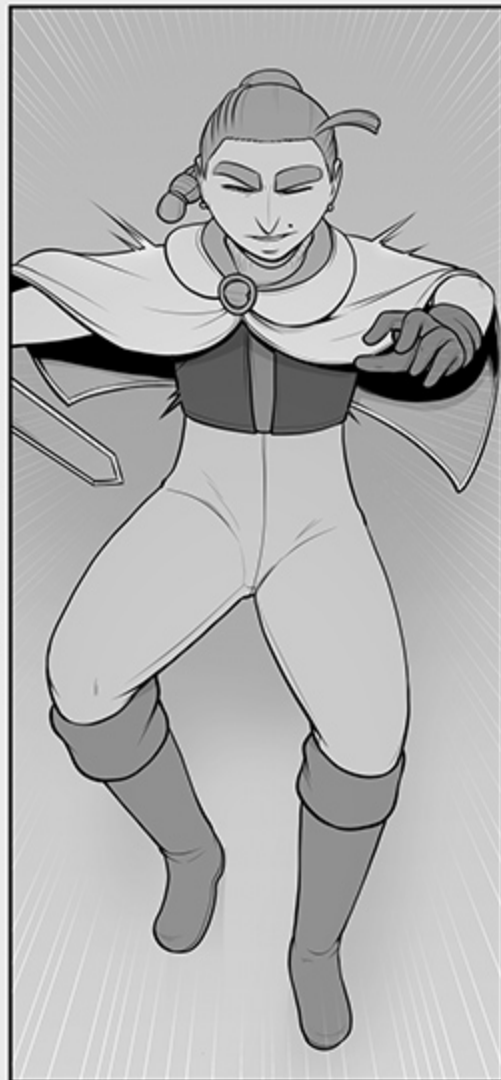

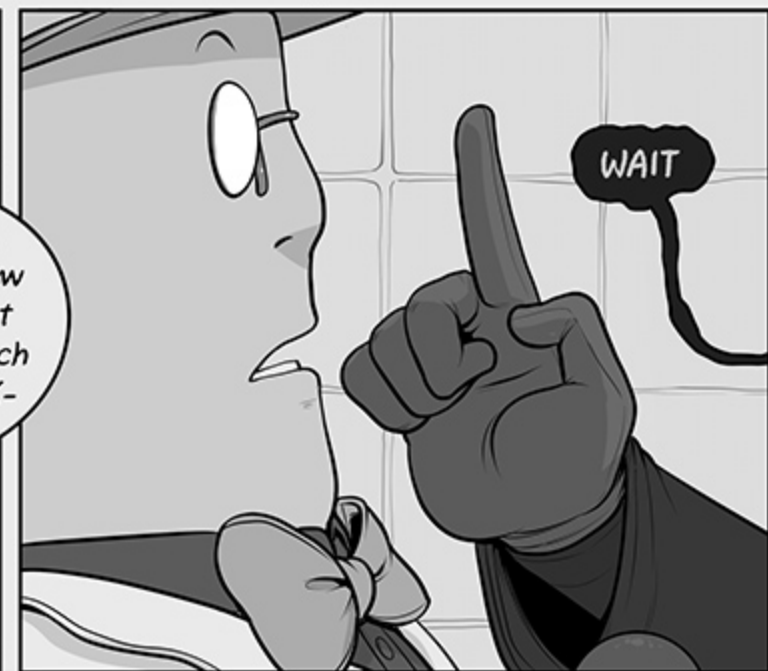
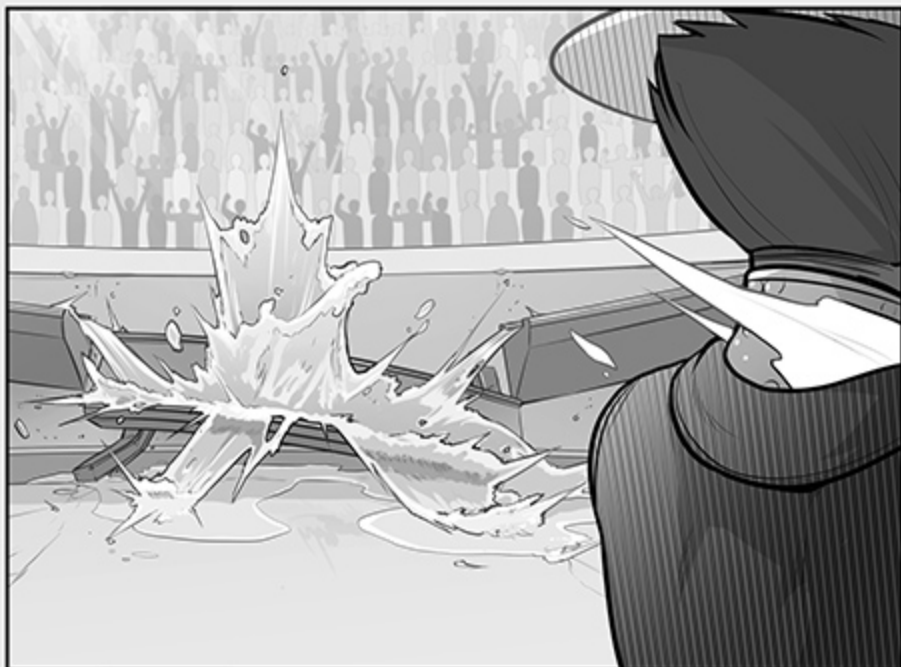
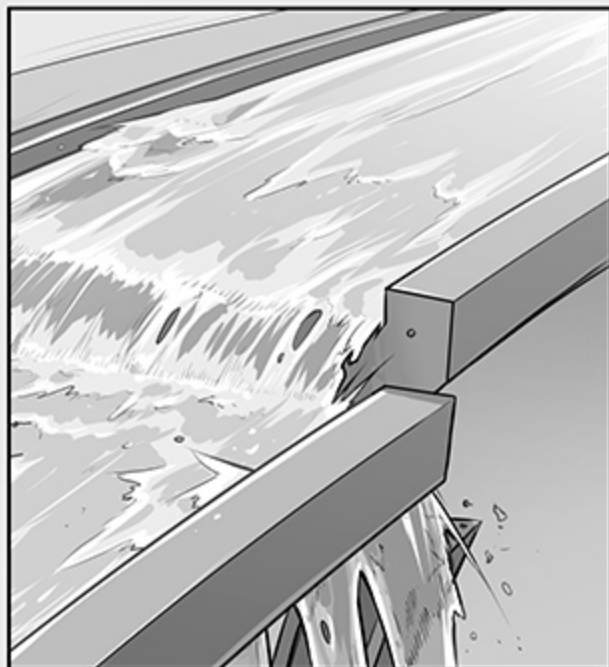



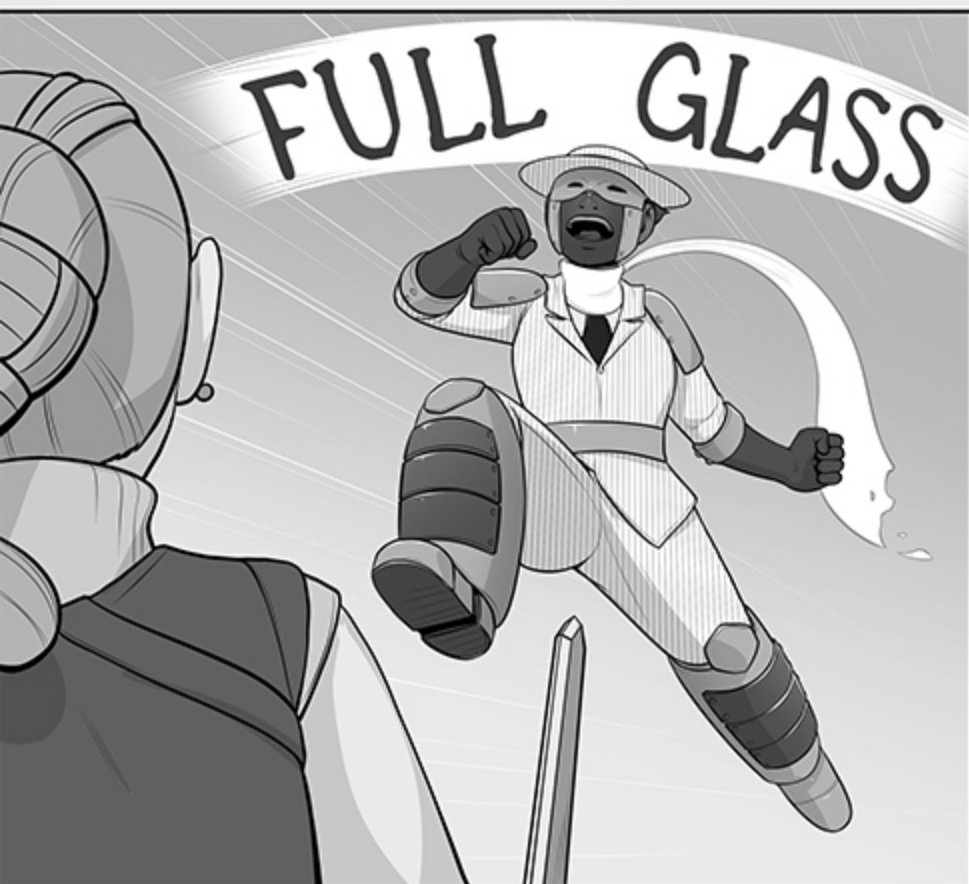



*Moxie Knight's
Moxie Sockdollager
activates all her Moxies
simultaneously-like,*

*But it puts a big
ol' strain on her.*



*I never heard of
her using it for
anything but a
finishin' blow!*

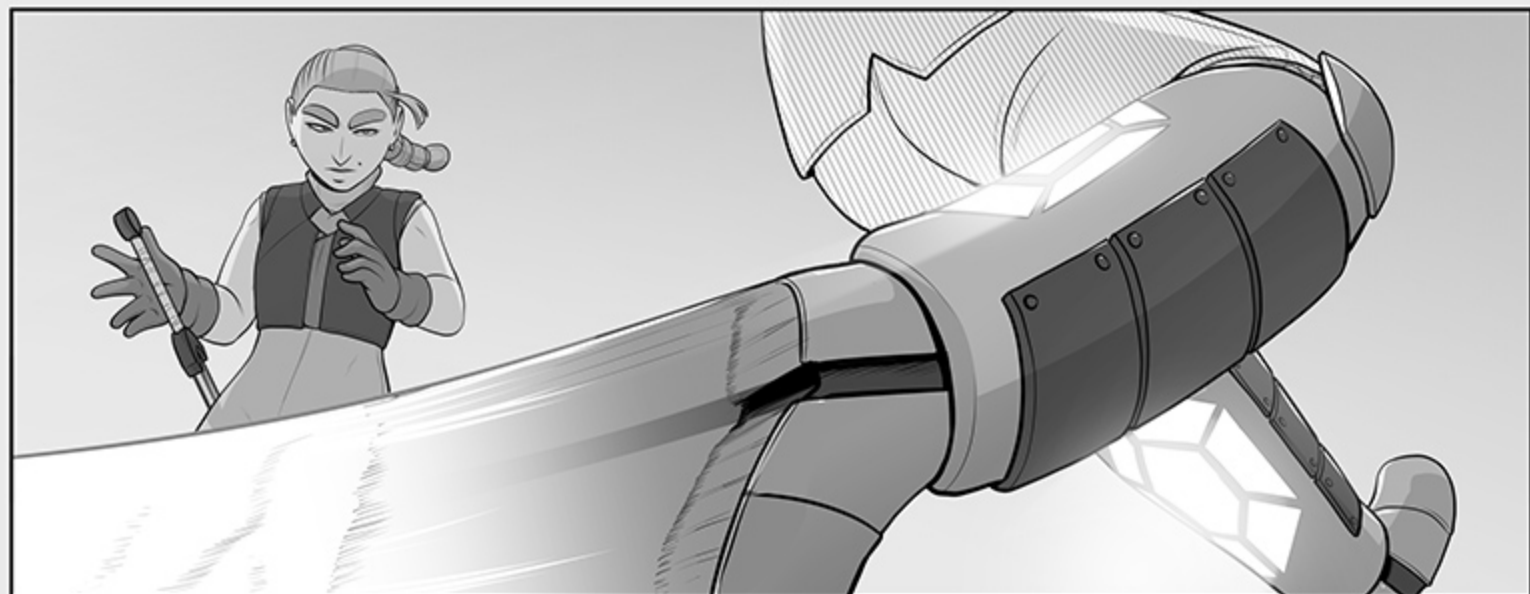
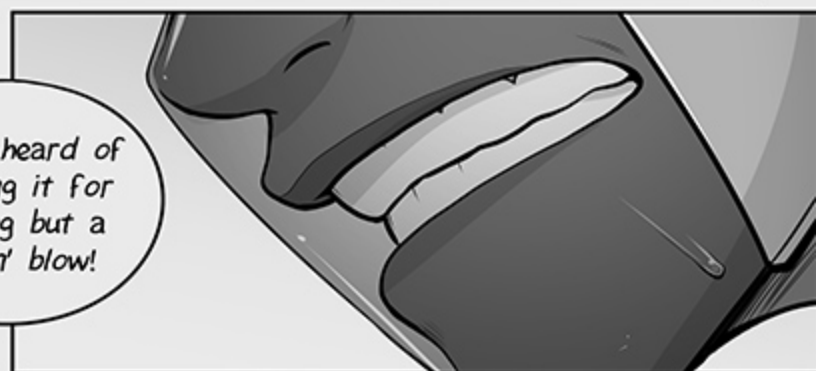



Hey
You know you're
just hitting me
with padding, right?

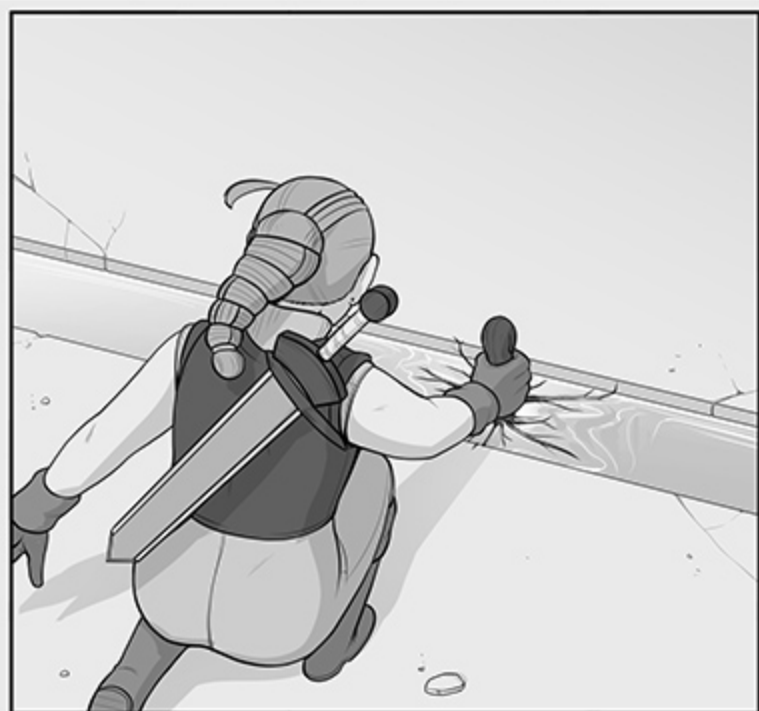
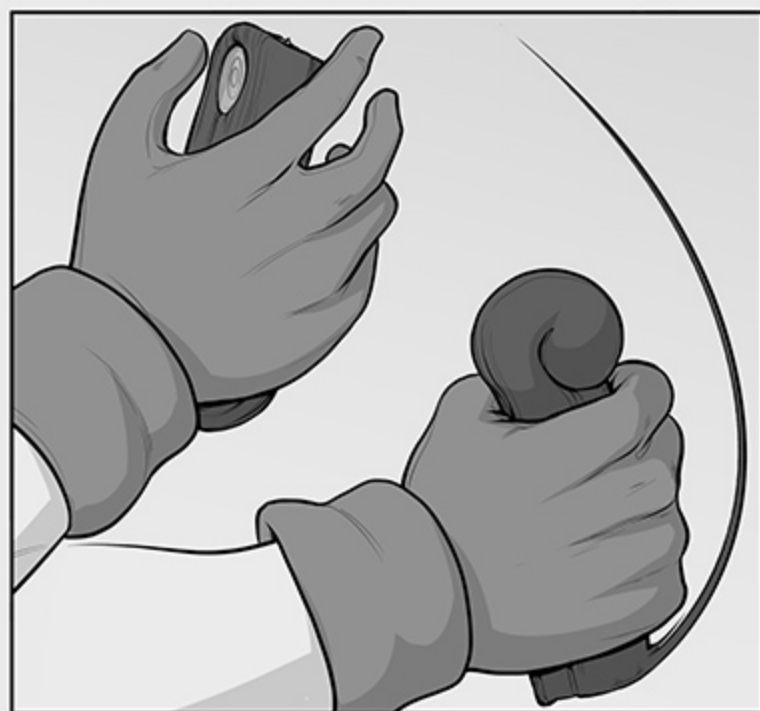



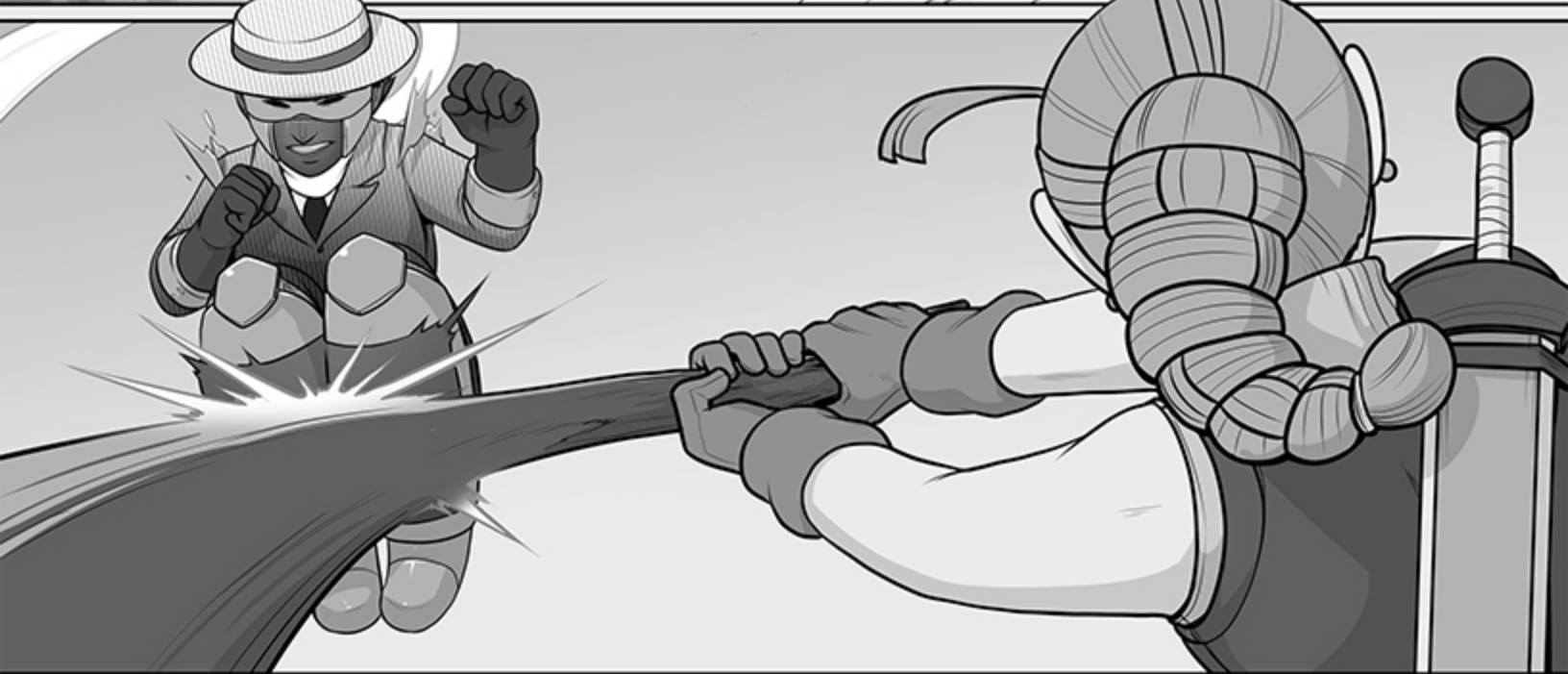
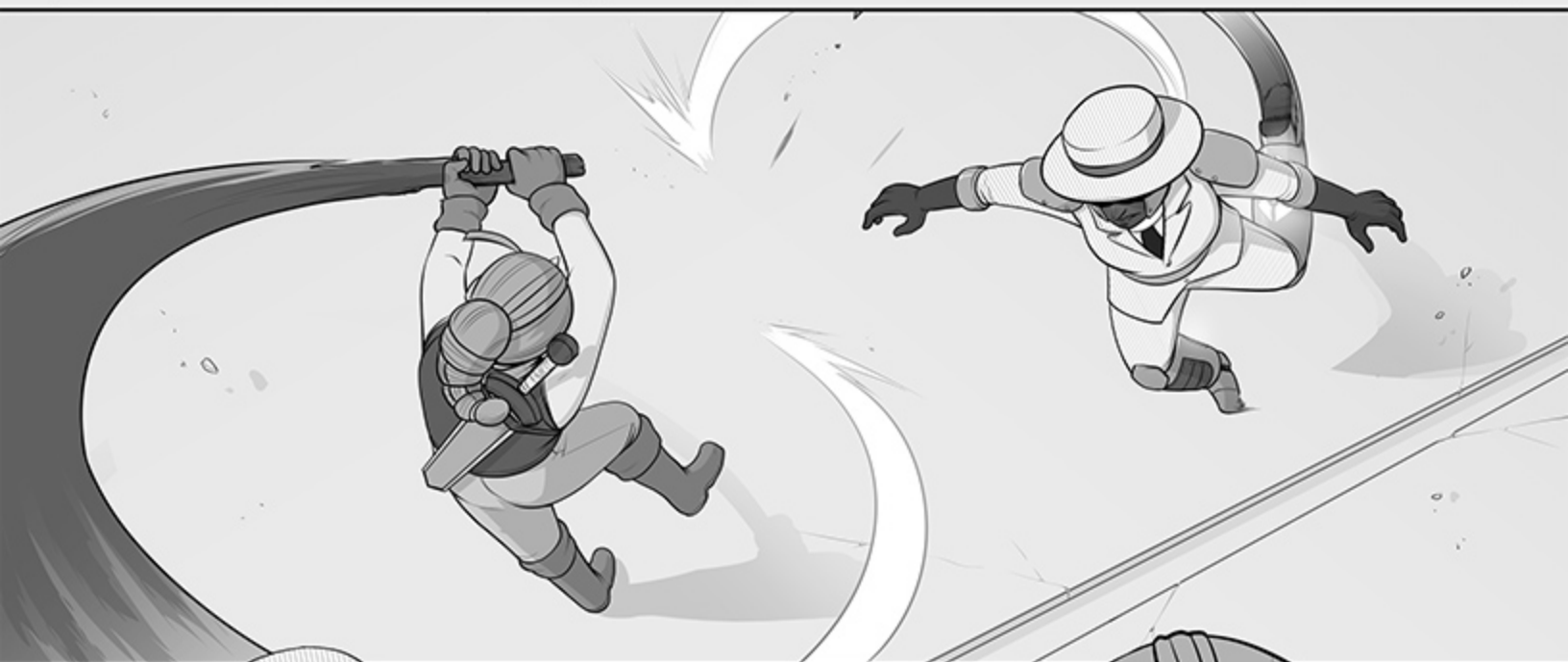

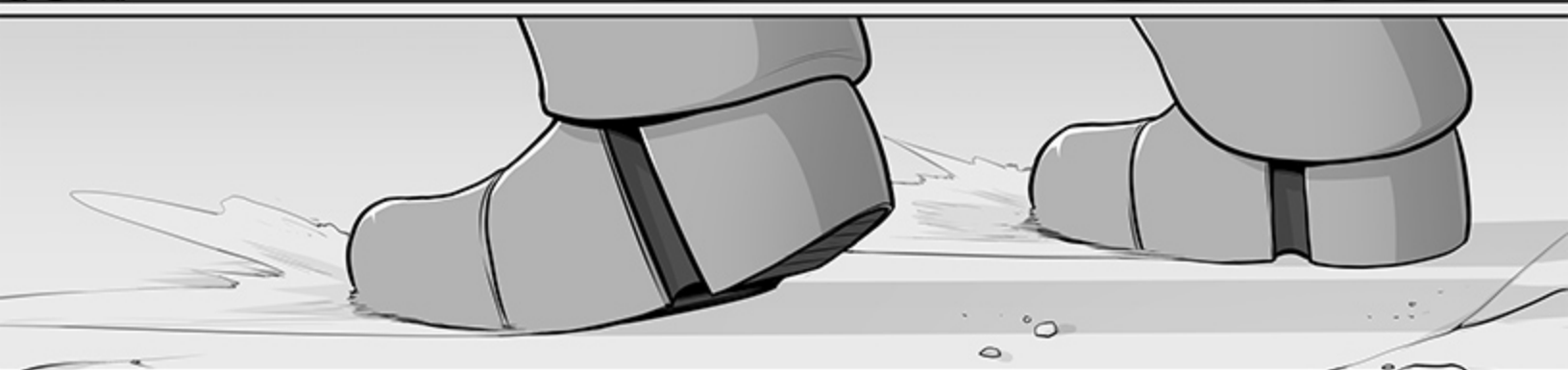
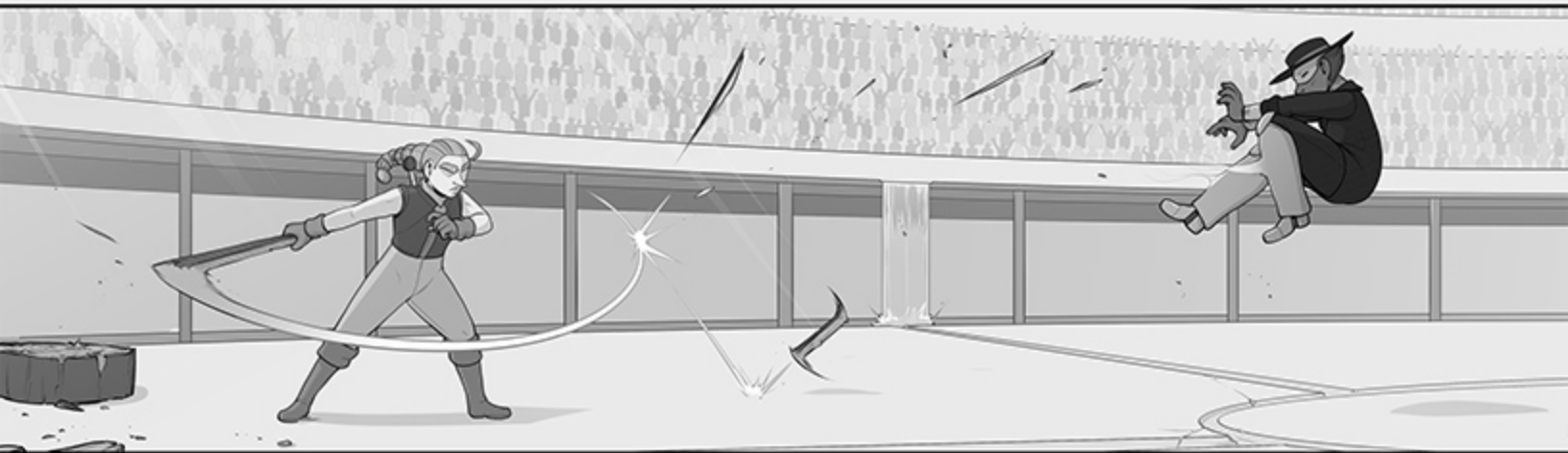

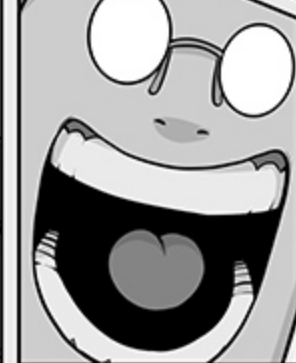
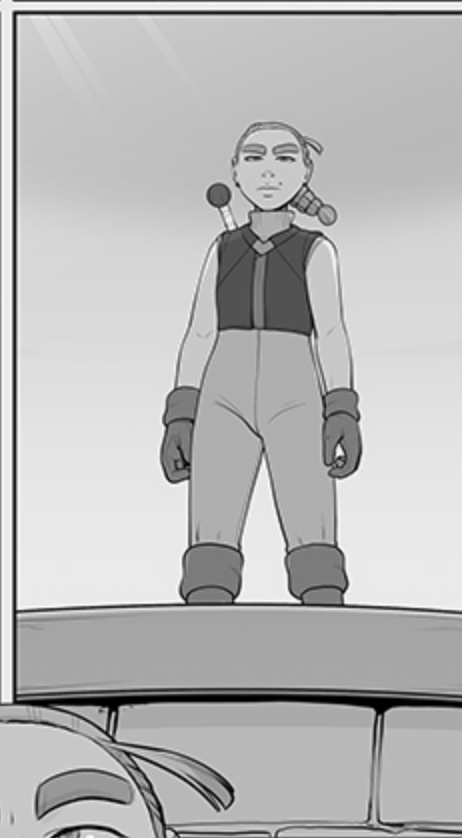
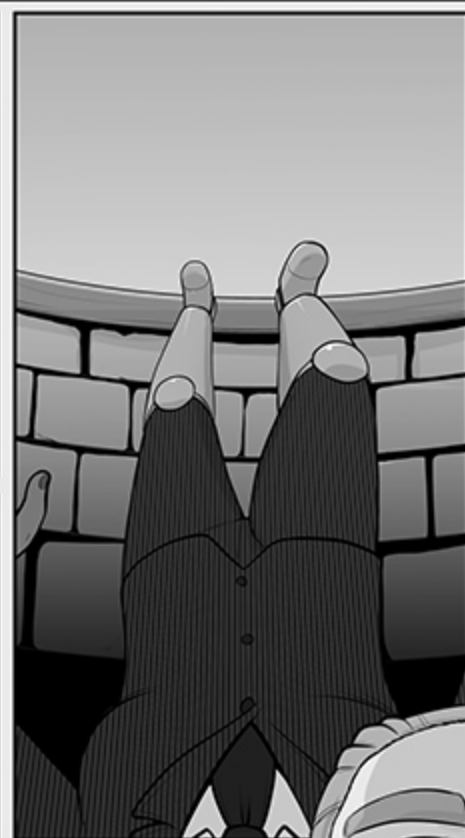
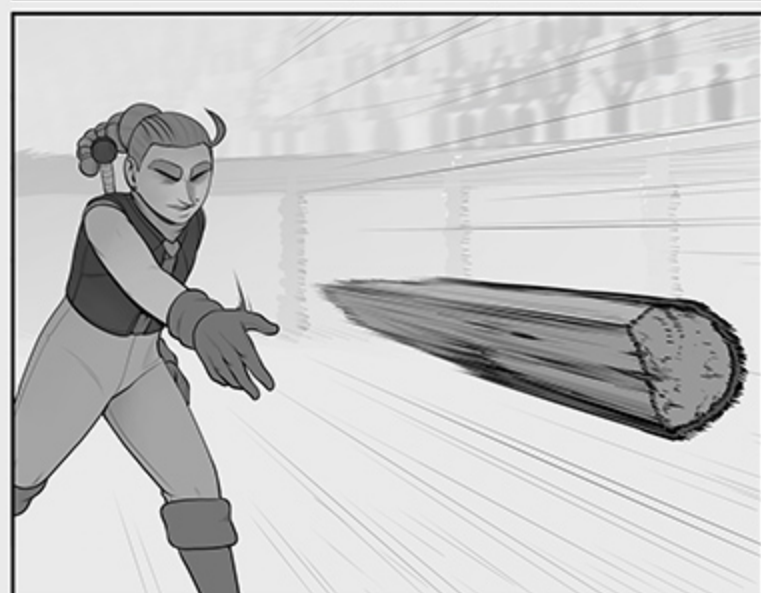

WINNER
BY
RING-IN



BRIANNE
IRONHEART



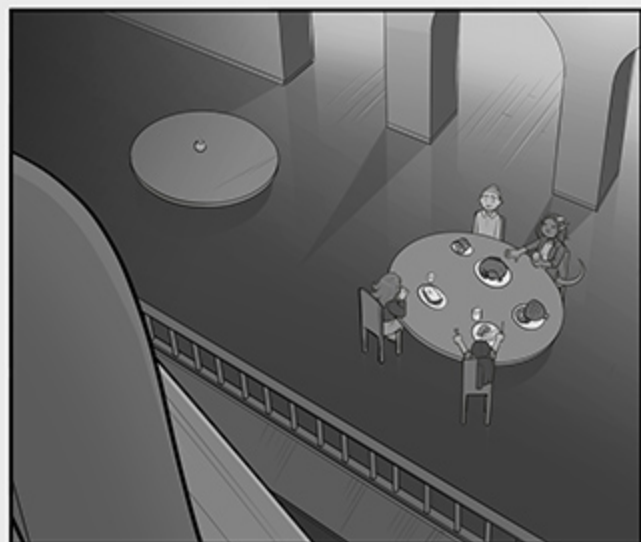

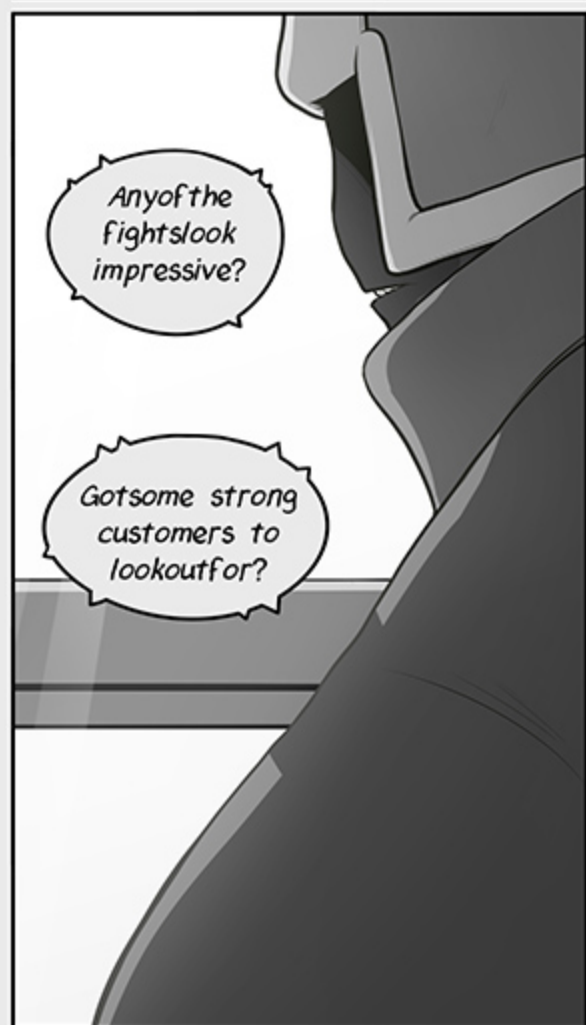
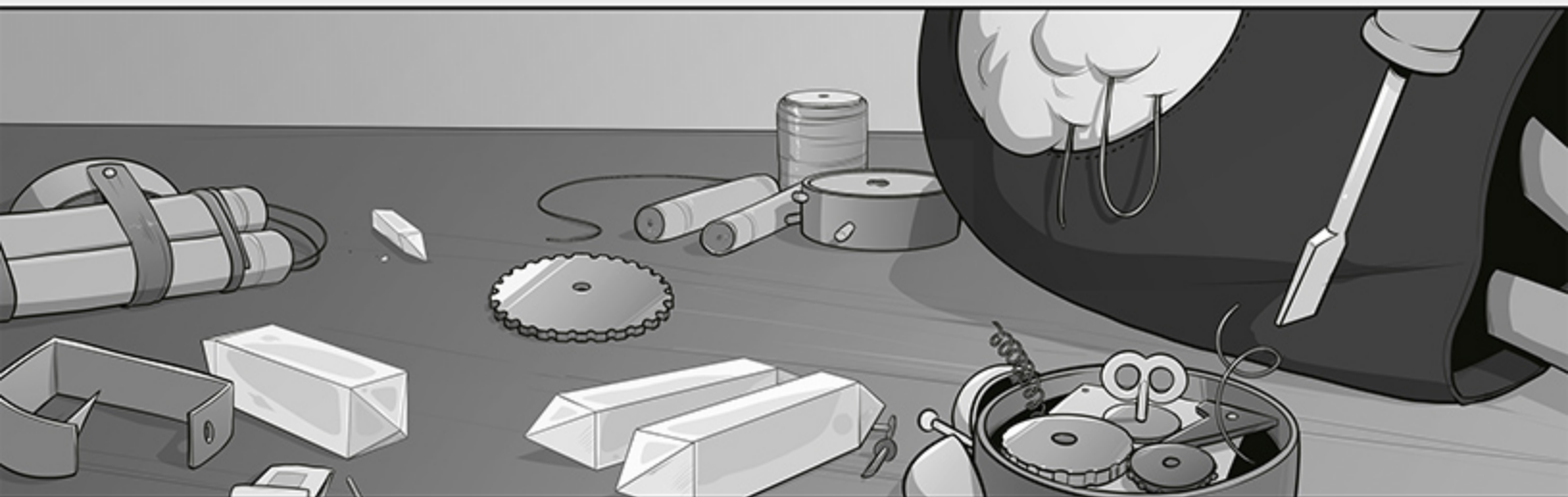

Thanks for reading!

Ironheart-Rune by Will Muzzi

ironheart-rune.com
itch.io/ironheart-rune

